



brevettato · patented
premio · award euroshop retail trend 2014

sistema di montanti elettrici e mensole illuminanti per interni realizzati in una speciale lega conduttrice.

montanti disponibili con lunghezze di 2000mm/78.7" e 3000mm/118.1".

modelli:

montantelettrico ma1 con gola singola, dimensioni 12x20mm/0.5x0.8"

per fissaggio a vista o a incasso,

montantelettrico ma2 con gola doppia, dimensioni 24x20mm/0.9x0.8"

per fissaggio a vista o a incasso,

montantelettrico mb1 con gola singola, dimensioni 39x20mm/1.5x0.8"

per fissaggio a scomparsa totale,

montantelettrico mb2 con gola doppia, dimensioni 54x20mm/2.1x0.8"

per fissaggio a scomparsa totale.

cablati con sorgenti elettroniche lineari, con limitatore di corrente integrato,

3000K 13W/m 24Vdc.

men sole: disponibili con profondità fino a 500mm/19.7" e lunghezza fino a 979mm/38.5",

la lunghezza 510mm/20.1" può essere inserita all'interno di mobili con moduli di

600mm/23.6".

modelli:

men sole 01 con doppia emissione,

men sole 02 con doppia emissione e appenderia,

men sole 03 senza sorgente luminosa,

men sole 04 con singola emissione e binario elettrificato predisposto per micromen

orientabile 1W 12°, 13°, 23° o 25°, 55x13mm/2.2x0.5" h.25mm/1".

accessori: vetro trasparente extrachiaro o nero; ripiani porta spezie, porta oggetti,

modulo lineare multifunzionale. finiture: telaio in alluminio lucido, nero, ottone ap-s; vetro

trasparente extrachiaro o nero.

dry location rated shelf system with electrified vertical rods (montantelettrico) for interior use, made of a special conductive alloy.

vertical rods available in the following lengths: 2000mm/78.7" and 3000mm/118.1".

versions:

montantelettrico ma1 with single tray, sizes 12x20mm/0.5x0.8"

for visible or recessed fixing,

montantelettrico ma2 with double tray, sizes 24x20mm/0.9x0.8"

for visible or recessed fixing,

montantelettrico mb1 with single tray, sizes 39x20mm/1.5x0.8"

for fully concealed fixing,

montantelettrico mb2 with double tray, sizes 54x20mm/2.1x0.8"

for fully concealed fixing.

wired with linear led sources 3000K 13W/m 24Vdc with current limiter integrated.

men sole available with depth up to 500mm/19.7" and length up to 979mm/38.5".

510mm/20.1" length can be inserted inside pieces of furniture with 600mm/23.6"

modules.

versions:

men sole 01 with double emission,

men sole 02 with double emission and clothes hangers,

men sole 03 without light source,

men sole 04 with single emission and electrified track designed to accommodate the 1W

12°, 13°, 23° or 25° adjustable micromen spotlight, 55x13mm/2.2x0.5" h.25mm".

accessories: extra-clear transparent or black glass; shelves for spices, objects,

multifunctional linear module.

finishes: polished aluminium, black, ottone ap-s frame; extra-clear transparent or black glass.



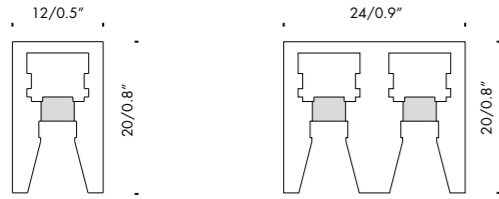

montantelettrico ma1
2000/3000mm
78.7"/118.1"
scala · scale 1:1

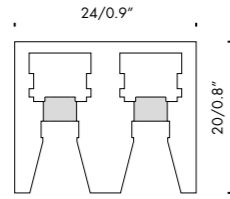

montantelettrico ma2
2000/3000mm
78.7"/118.1"
scala · scale 1:1

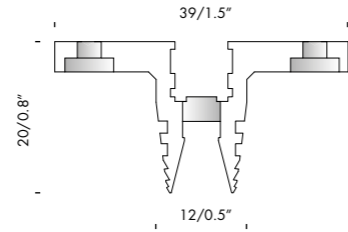

montantelettrico mb1
2000/3000mm
78.7"/118.1"
scala · scale 1:1

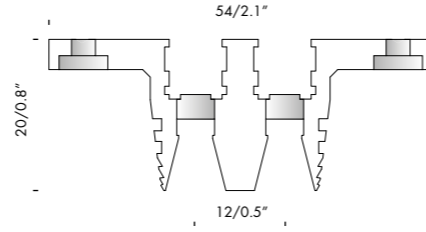

montantelettrico mb2
2000/3000mm
78.7"/118.1"
scala · scale 1:1



montaggio a vista o incasso · visible or recessed fixing



montaggio a scomparsa totale · fully concealed fixing

men sole
profondità · depth 170mm/6.7"

170x333mm
6.7x13.1"

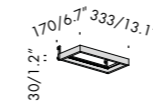

170x656mm
6.7x25.8"

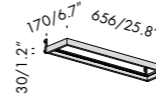

170x979mm
6.7x38.5"

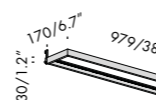

men sole
profondità · depth 333mm/13.1"

333x333mm
13.1x13.1"

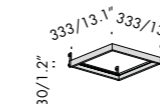

333x656mm
13.1x25.8"

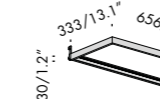

333x979mm
13.1x38.5"

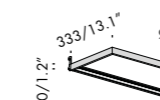

men sole
profondità · depth 450mm/17.7"

450x333mm
17.7x13.1"

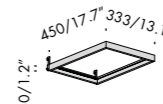

450x510mm
17.7x20.1"



450x656mm
17.7x25.8"

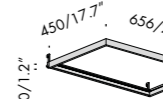

450x979mm
17.7x38.5"

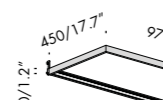

men sole
profondità · depth 500mm/19.7"

500x333mm
19.7x13.1"

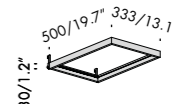

500x656mm
19.7x25.8"

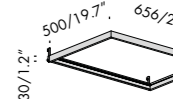

500x979mm
19.7x38.5"

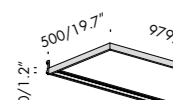

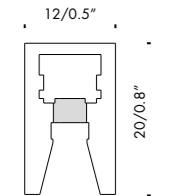

montantelettrico ma1
scala · scale 1:1

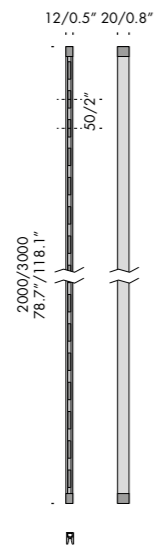

R

montantelettrico ma1		24Vdc	dry	Ⓜ	i
Vb6.528.61	alluminio lucido · polished aluminium	2000mm 78.7"	0,9kg 2lb		
Vb6.528.62	nero · black	2000mm 78.7"	0,9kg 2lb		
Vb6.528.63	ottone ap-s	2000mm 78.7"	0,9kg 2lb		
f6.528.01.2	alluminio lucido · polished aluminium	3000mm 118.1"	1,3kg 2.9lb		
f6.528.02.2	nero · black	3000mm 118.1"	1,3kg 2.9lb		
Vb6.528.03	ottone ap-s	3000mm 118.1"	1,3kg 2.9lb		

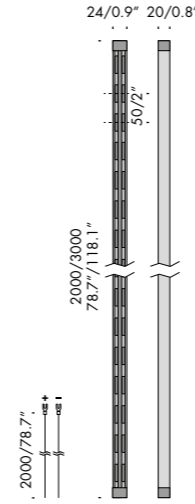

R

montantelettrico ma2		24Vdc	dry	Ⓜ	i
Vb6.528.71	alluminio lucido · polished aluminium	2000mm 78.7"	1,7kg 3.7lb		
Vb6.528.72	nero · black	2000mm 78.7"	1,7kg 3.7lb		
Vb6.528.73	ottone ap-s	2000mm 78.7"	1,7kg 3.7lb		
Vb6.528.76	alluminio lucido · polished aluminium	3000mm 118.1"	2,5kg 5.5lb		
Vb6.528.77	nero · black	3000mm 118.1"	2,5kg 5.5lb		
Vb6.528.78	ottone ap-s	3000mm 118.1"	2,5kg 5.5lb		

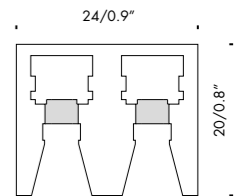

montantelettrico ma2
scala · scale 1:1

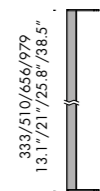
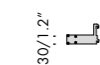
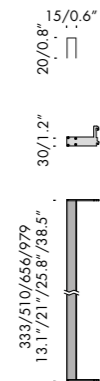

accessori. accessories.				Ⓜ	i
f9.528.90	isolante · insulating	3000mm 118.1"	0,3kg 0.7lb		
Vb9.528.100	dima per installazione · installation template	333mm 13.1"	0,4kg 0.9lb		
Vb9.528.103	dima per installazione · installation template	510mm 20.1"	0,6kg 1.3lb		
Vb9.528.101	dima per installazione · installation template	656mm 25.8"	0,7kg 1.5lb		
Vb9.528.102	dima per installazione · installation template	979mm 38.6"	0,9kg 2lb		

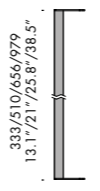

accessori. accessories.				Ⓜ	i
Vb9.528.51	morsetto di connessione per montantelettrico ma2, mb1 e mb2 connection clip for montantelettrico ma2, mb1 and mb2		0,3kg 0.7lb		
Vb9.528.100	dima per installazione · installation template	333mm 13.1"	0,4kg 0.9lb		
Vb9.528.103	dima per installazione · installation template	510mm 20.1"	0,6kg 1.3lb		
Vb9.528.101	dima per installazione · installation template	656mm 25.8"	0,7kg 1.5lb		
Vb9.528.102	dima per installazione · installation template	979mm 38.6"	0,9kg 2lb		

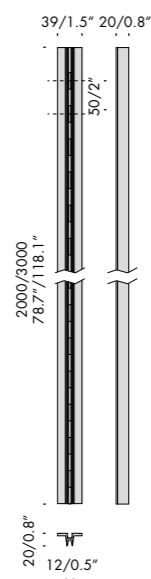
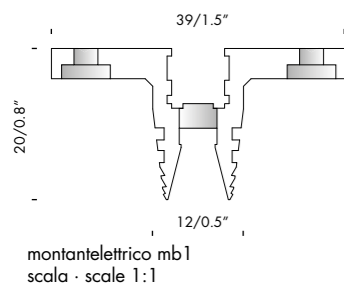

montantelettrico mb1 24Vdc

Vb6.528.81	nero · black	2000mm 78.7"	1,4kg 3.1lb
Vb6.528.86	nero · black	3000mm 118.1"	2kg 4.4lb

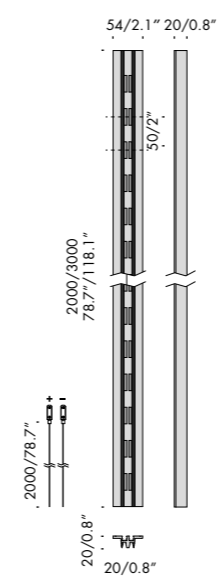

montantelettrico mb2 24Vdc

Vb6.528.91	nero · black	2000mm 78.7"	2kg 4.4lb
Vb6.528.96	nero · black	3000mm 118.1"	3kg 6.6lb

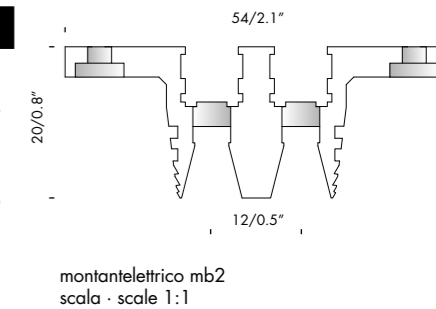

accessori. accessories.

Vb9.528.51	morsetto di connessione per montantelettrico ma2, mb1 e mb2 connection clip for montantelettrico ma2, mb1 and mb2	0,3kg 0.7lb
Vb9.528.100	dima per installazione · installation template	333mm 0,4kg 13.1" 0.9lb
Vb9.528.103	dima per installazione · installation template	510mm 0,6kg 20.1" 1.3lb
Vb9.528.101	dima per installazione · installation template	656mm 0,7kg 25.8" 1.5lb
Vb9.528.102	dima per installazione · installation template	979mm 0,9kg 38.5" 2lb

accessori. accessories.

Vb9.528.51	morsetto di connessione per montantelettrico ma2, mb1 e mb2 connection clip for montantelettrico ma2, mb1 and mb2	0,3kg 0.7lb
Vb9.528.100	dima per installazione · installation template	333mm 0,4kg 13.1" 0.9lb
Vb9.528.103	dima per installazione · installation template	510mm 0,6kg 20.1" 1.3lb
Vb9.528.101	dima per installazione · installation template	656mm 0,7kg 25.8" 1.5lb
Vb9.528.102	dima per installazione · installation template	979mm 0,9kg 38.5" 2lb

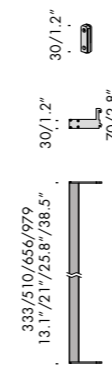
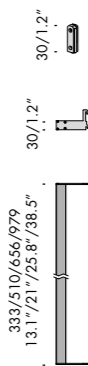

montantelettrico ma1

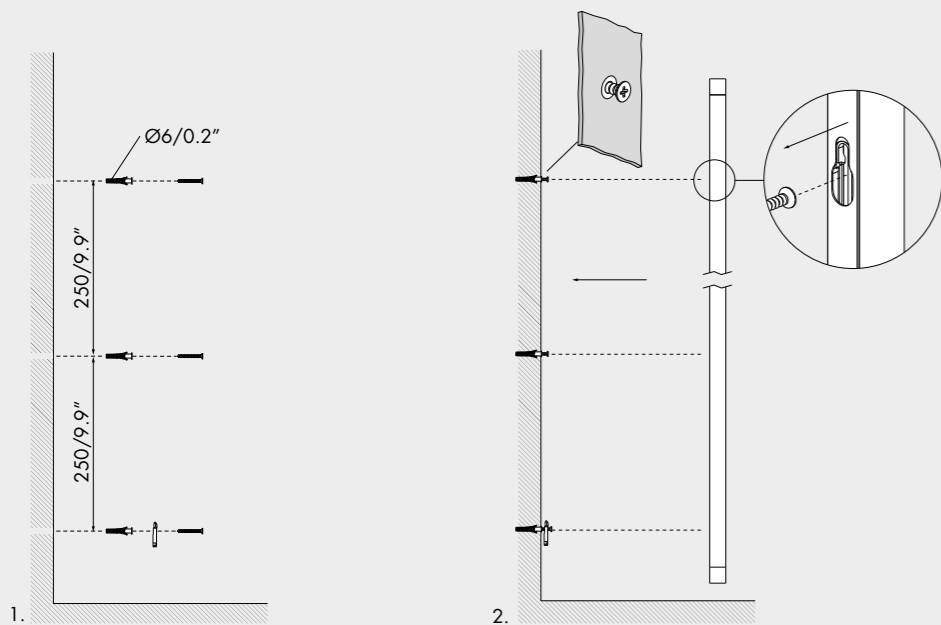

il fissaggio a parete del montantelettrico deve essere eseguito da personale qualificato utilizzando viti e tasselli adeguati al supporto di installazione. condizioni ambientali di funzionamento: temperatura ambiente max 35°C, umidità relativa max 80%.

the montantelettrico wall fixing must be undertaken by qualified tradesmen. use appropriate screws and dowels for the installation support. ambient and operating conditions: ambient temperature max 35°C, relative humidity max 80%.

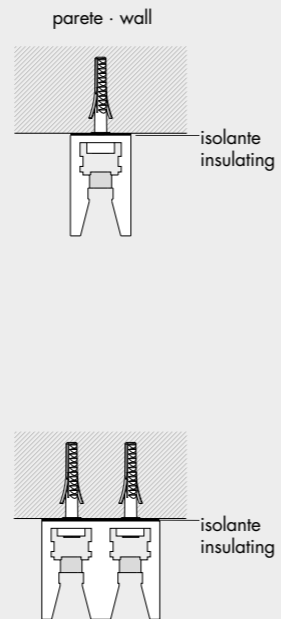
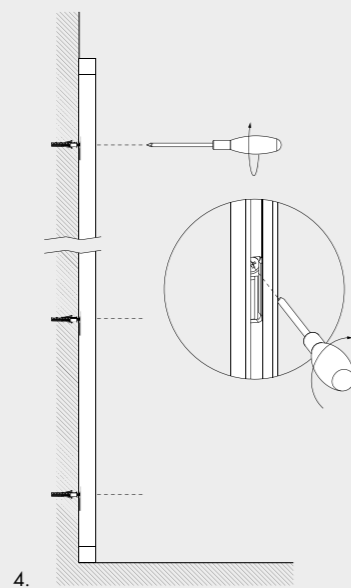
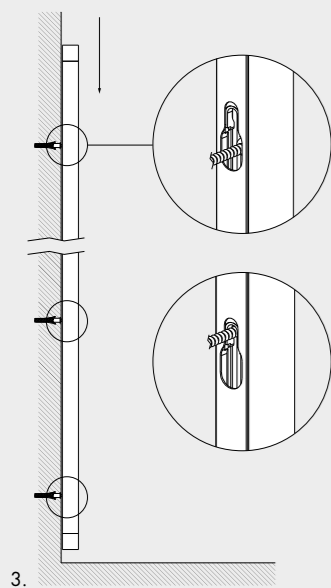

montantelettrico mb1

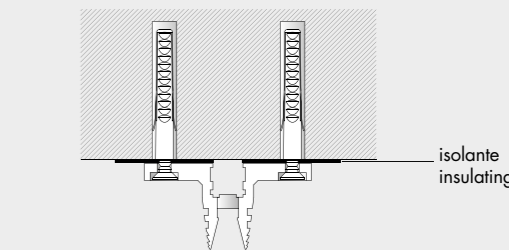
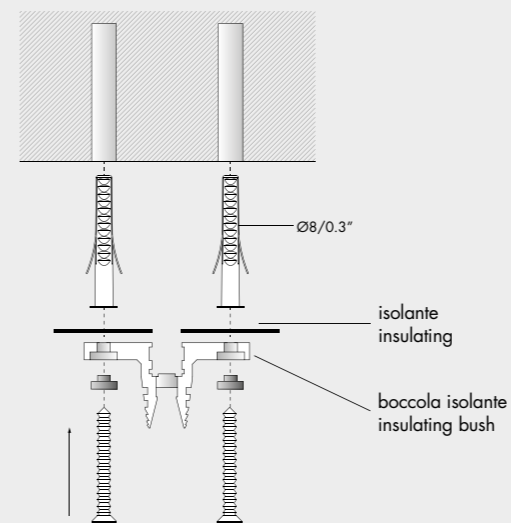

il fissaggio a parete del montantelettrico deve essere eseguito da personale qualificato utilizzando viti e tasselli adeguati al supporto di installazione. condizioni ambientali di funzionamento: temperatura ambiente max 35°C, umidità relativa max 80%.

the montantelettrico wall fixing must be undertaken by qualified tradesmen. use appropriate screws and dowels for the installation support. ambient and operating conditions: ambient temperature max 35°C, relative humidity max 80%.

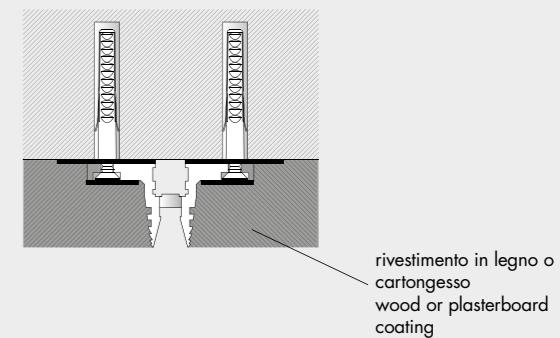
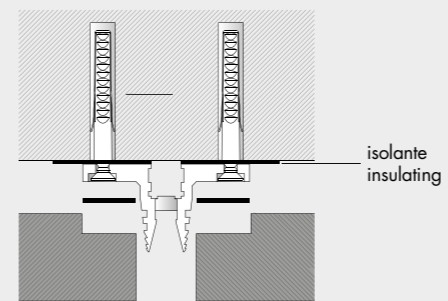

men sole 170x333/01

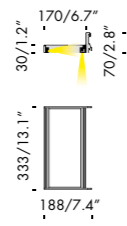
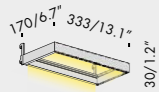

men sole 170x333/02

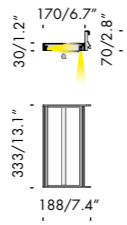

men sole 170x333/03

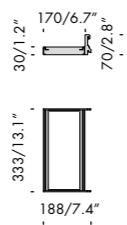
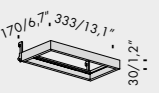

men sole 170x333/01 24Vdc

- f6.529.01** cornice alluminio lucido senza ripiano 3000K 8,6W 333mm 0,7kg
polished aluminium frame without shelf 13.1" 1.6lb
- f6.529.02** cornice nero senza ripiano 3000K 8,6W 333mm 0,7kg
black frame without shelf 13.1" 1.6lb
- Vb6.529.09** cornice ottone ap-s senza ripiano 3000K 8,6W 333mm 0,7kg
ottone ap-s frame without shelf 13.1" 1.6lb

Ra	R9	ies tm/30		sdcm	Vf	lm/m	W/m	lm/W
95	90	Rf 93	Rg 102	step 2	24	1250	13	96
V0001	5,9	Ta25 °C		vita media · average life	50000 h	L80	B10	

men sole 170x333/02 24Vdc

- f6.529.03** appendiabiti alluminio lucido senza ripiano 3000K 8,6W 333mm 0,8kg
polished aluminium clothes hanger without shelf 13.1" 1.8lb
- f6.529.04** appendiabiti nero senza ripiano 3000K 8,6W 333mm 0,8kg
black clothes hanger without shelf 13.1" 1.8lb
- Vb6.529.10** appendiabiti ottone ap-s senza ripiano 3000K 8,6W 333mm 0,8kg
ottone ap-s clothes hanger without shelf 13.1" 1.8lb

Ra	R9	ies tm/30		sdcm	Vf	lm/m	W/m	lm/W
95	90	Rf 93	Rg 102	step 2	24	1250	13	96
V0001	5,9	Ta25 °C		vita media · average life	50000 h	L80	B10	

men sole 170x333/03

- f6.529.05** cornice cieca alluminio lucido senza ripiano 333mm 0,7kg
polished aluminium blind frame without shelf 13.1" 1.6lb
- f6.529.06** cornice cieca nero senza ripiano 333mm 0,7kg
black blind frame without shelf 13.1" 1.6lb
- Vb6.529.19** cornice cieca ottone ap-s senza ripiano 333mm 0,7kg
ottone ap-s blind frame without shelf 13.1" 1.6lb



men sole 170x333/04
max 2 micromen

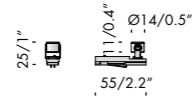
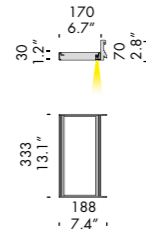
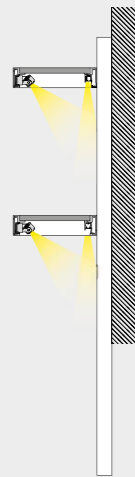
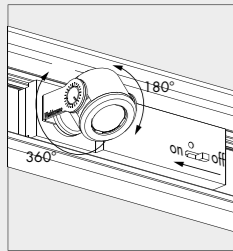
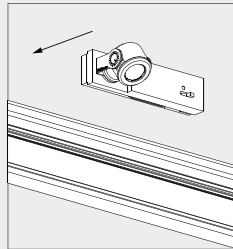
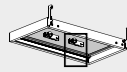

men sole 170x333/04 24Vdc

- f6.529.07** cornice alluminio lucido senza ripiano con binario elettrificato per micromen
polished aluminium frame without shelf electrified track for micromen 3000K 4,3W 333mm 0,7kg 13.1" 1.6lb
- f6.529.08** cornice nero senza ripiano con binario elettrificato per micromen
black frame without shelf electrified track for micromen 3000K 4,3W 333mm 0,7kg 13.1" 1.6lb
- Vb6.529.20** cornice ottone ap-s senza ripiano con binario elettrificato per micromen
ottone ap-s frame without shelf electrified track for micromen 3000K 4,3W 333mm 0,7kg 13.1" 1.6lb

Ra	R9	ies tm/30	sdcm	Vf	lm/m	W/m	lm/W
95	90	Rf 93 Rg 102	step 2	24	1250	13	96
V0001	5,9	Ta25 °C	vita media · average life	50000 h	L80	B10	

micromen 24Vdc

- Vb9.528.55.1** alluminio lucido adattatore nero55 3000K 13° 0,02kg 0.04lb
polished aluminium nero55 adapter
- Vb9.528.56** alluminio lucido adattatore nero55 3000K 25° 0,02kg 0.04lb
polished aluminium nero55 adapter
- Vb9.528.57** nero55 adattatore nero55 3000K 12° 0,02kg 0.04lb
nero55 adapter
- Vb9.528.58** nero55 adattatore nero55 3000K 23° 0,02kg 0.04lb
nero55 adapter

Ra	ies tm-30	sdcm	mA	V _{f (min)}	lm	W	lm/W
90	Rf 90 Rg 100	step 2	300	2,8	90	1	90
ca011	les2	Ta25 °C	vita media · average life	50000 h	L80	B10	

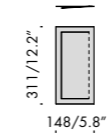
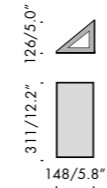
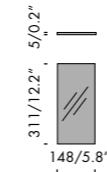
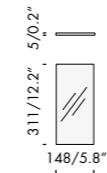

componenti. components.

- f9.529.61** ripiano vetro glass shelf extra chiaro extra-clear 311mm 0,6kg 12.2" 1.3lb
- f9.529.61.n** ripiano vetro glass shelf nero black 311mm 0,7kg 12.2" 1.5lb
- f9.529.63** porta oggetti cromo roof chrome nero black 311mm 1kg 12.2" 2.2lb
- f9.529.64** porta spezie cromo spices standing chrome nero black 311mm 1kg 12.2" 2.2lb

men sole 170x333

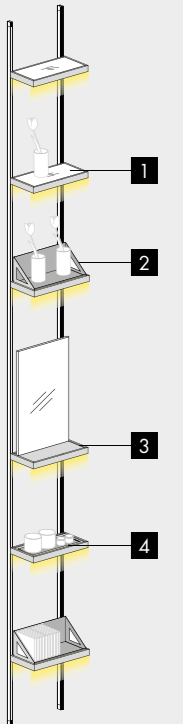

- 1** ripiano vetro extra chiaro glass shelf extra-clear
- 2** porta oggetti cromo nero roof black chrome
- 3** ripiano vetro nero black glass shelf
- 4** porta spezie cromo nero spices standing black chrome

men sole 170x656/01

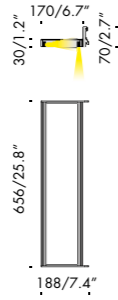
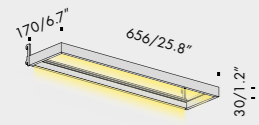

men sole 170x656/02

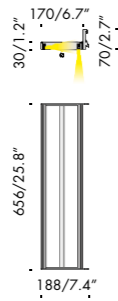
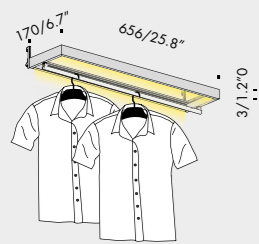

men sole 170x656/03

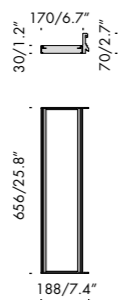
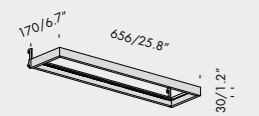

men sole 170x656/01 24Vdc dry

- f6.529.11** cornice alluminio lucido senza ripiano 3000K 17W 656mm 1,2kg
polished aluminium frame without shelf 25.8" 2.6lb
- f6.529.12** cornice nero senza ripiano 3000K 17W 656mm 1,2kg
black frame without shelf 25.8" 2.6lb
- Vb6.529.29** cornice ottone aps senza ripiano 3000K 17W 656mm 1,2kg
ottone aps frame without shelf 25.8" 2.6lb

Ra	R9	ies tm/30		sdcm	Vf	lm/m	W/m	lm/W
95	90	Rf 93	Rg 102	step 2	24	1250	13	96
V0001		5,9 Ta25 °C		vita media · average life		50000 h	L80	B10

men sole 170x656/02 24Vdc dry

- f6.529.13** appendiabiti alluminio lucido senza ripiano 3000K 17W 656mm 1,4kg
polished aluminium clothes hanger without shelf 25.8" 3.1lb
- f6.529.14** appendiabiti nero senza ripiano 3000K 17W 656mm 1,4kg
black clothes hanger without shelf 25.8" 3.1lb
- Vb6.529.30** appendiabiti ottone aps senza ripiano 3000K 17W 656mm 1,4kg
ottone aps clothes hanger without shelf 25.8" 3.1lb

Ra	R9	ies tm/30		sdcm	Vf	lm/m	W/m	lm/W
95	90	Rf 93	Rg 102	step 2	24	1250	13	96
V0001		5,9 Ta25 °C		vita media · average life		50000 h	L80	B10

men sole 170x656/03 dry

- f6.529.15** cornice cieca alluminio lucido senza ripiano 656mm 1,2kg
polished aluminium blind frame without shelf 25.8" 2.6lb
- f6.529.16** cornice cieca nero senza ripiano 656mm 1,2kg
black blind frame without shelf 25.8" 2.6lb
- Vb6.529.31** cornice cieca ottone aps senza ripiano 656mm 1,2kg
ottone aps blind frame without shelf 25.8" 2.6lb



men sole 170x656/04
max 4 micromen

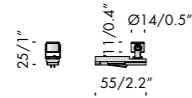
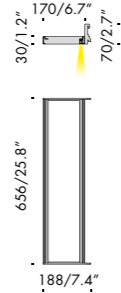
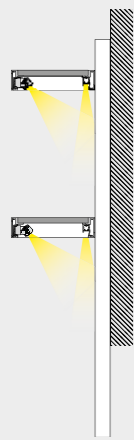
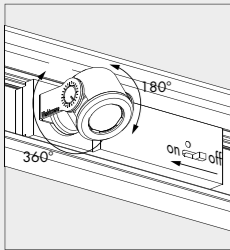
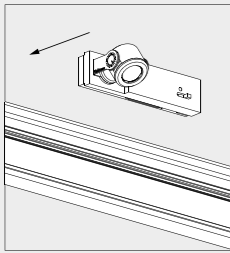
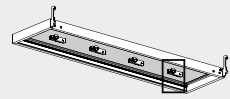

men sole 170x656/04 24Vdc

- f6.529.17** cornice alluminio lucido senza ripiano con binario elettrificato per micromen
polished aluminium frame without shelf electrified track for micromen 3000K 8,5W 656mm 1,2kg 25.8" 2.6lb
- f6.529.18** cornice nero senza ripiano con binario elettrificato per micromen
black frame without shelf electrified track for micromen 3000K 8,5W 656mm 1,2kg 25.8" 2.6lb
- Vb6.529.32** cornice ottone ap-s senza ripiano con binario elettrificato per micromen
ottone ap-s frame without shelf electrified track for micromen 3000K 8,5W 656mm 1,2kg 25.8" 2.6lb

Ra	R9	ies tm/30		sdc	Vf	lm/m	W/m	lm/W
95	90	Rf 93	Rg 102	step 2	24	1250	13	96
V0001	5,9	Ta25 °C		vita media · average life		50000 h	L80	B10

micromen 24Vdc

- Vb9.528.55.1** alluminio lucido adattatore nero55 3000K 13° 0,02kg 0.04lb
polished aluminium nero55 adapter
- Vb9.528.56** alluminio lucido adattatore nero55 3000K 25° 0,02kg 0.04lb
polished aluminium nero55 adapter
- Vb9.528.57** nero55 adattatore nero55 3000K 12° 0,02kg 0.04lb
nero55 adapter
- Vb9.528.58** nero55 adattatore nero55 3000K 23° 0,02kg 0.04lb
nero55 adapter

Ra	ies tm-30		sdc	mA	V _f (min)	lm	W	lm/W
90	Rf 90	Rg 100	step 2	300	2,8	90	1	90
ca011	les2		Ta25 °C		vita media · average life		50000 h	L80 B10

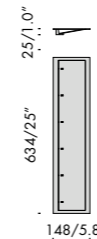
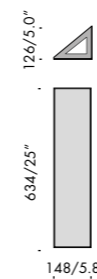
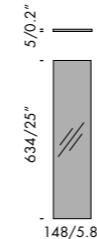

componenti. components.

- f9.529.66** ripiano vetro glass shelf extra chiaro extra-clear 634mm 25" 1,1kg 2.4lb
- f9.529.66.n** ripiano vetro glass shelf nero black 634mm 25" 1,4kg 3.1lb
- f9.529.68** porta oggetti cromo roof chrome nero black 634mm 25" 1,9kg 4.2lb
- f9.529.69** porta spezie cromo spices standing chrome nero black 634mm 25" 1,9kg 4.2lb

men sole 170x656

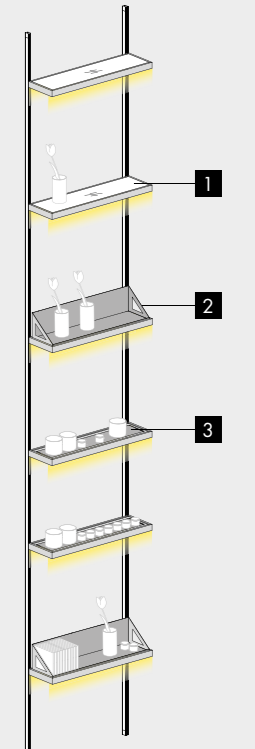

- 1** ripiano vetro extra chiaro glass shelf extra-clear
- 2** porta oggetti cromo nero roof black chrome
- 3** porta spezie cromo nero spices standing black chrome

men sole 170x959/01

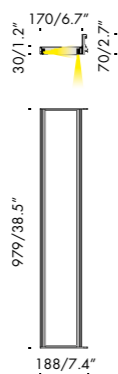
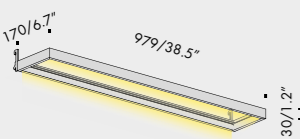

men sole 170x979/02

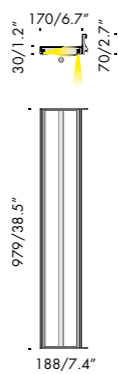
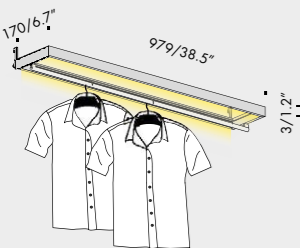

men sole 170x979/03

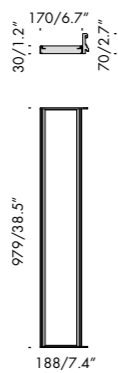

men sole 170x979/01 24Vdc

- f6.529.21** cornice alluminio lucido senza ripiano 3000K 26W 979mm 1,6kg
polished aluminium frame without shelf 38.5" 3.5lb
- f6.529.22** cornice nero senza ripiano 3000K 26W 979mm 1,6kg
black frame without shelf 38.5" 3.5lb
- Vb6.529.36** cornice ottone ap-s senza ripiano 3000K 26W 979mm 1,6kg
ottone ap-s frame without shelf 38.5" 3.5lb

Ra	R9	ies tm/30		sdc	Vf	lm/m	W/m	lm/W
95	90	Rf 93	Rg 102	step 2	24	1250	13	96
V0001		5,9 Ta25 °C		vita media · average life		50000 h	L80	B10

men sole 170x979/02 24Vdc

- f6.529.23** appendiabiti alluminio lucido 3000K 26W 979mm 2kg
senza ripiano polished aluminium clothes hanger without shelf 38.5" 4.4lb
- f6.529.24** appendiabiti nero senza ripiano 3000K 26W 979mm 2kg
black clothes hanger without shelf 38.5" 4.4lb
- Vb6.529.37** appendiabiti ottone ap-s senza ripiano 3000K 26W 979mm 2kg
ottone ap-s clothes hanger without shelf 38.5" 4.4lb

Ra	R9	ies tm/30		sdc	Vf	lm/m	W/m	lm/W
95	90	Rf 93	Rg 102	step 2	24	1250	13	96
V0001		5,9 Ta25 °C		vita media · average life		50000 h	L80	B10

men sole 170x979/03

- f6.529.25** cornice cieca alluminio lucido senza ripiano 979mm 1,8kg
polished aluminium blind frame without shelf 38.5" 4lb
- f6.529.26** cornice cieca nero senza ripiano 979mm 1,8kg
black blind frame without shelf 38.5" 4lb
- Vb6.529.38** cornice cieca ottone ap-s senza ripiano 979mm 1,8kg
ottone ap-s blind frame without shelf 38.5" 4lb

men sole 170x979/04 24Vdc

- f6.529.27** cornice alluminio lucido senza ripiano 3000K 13W 979mm 1,6kg
con binario elettrificato per micromen polished aluminium frame without shelf electrified track for micromen 38.5" 3.5lb
- f6.529.28** cornice nero senza ripiano 3000K 13W 979mm 1,6kg
con binario elettrificato per micromen black frame without shelf electrified track for micromen 38.5" 3.5lb
- Vb6.529.39** cornice ottone ap-s senza ripiano 3000K 13W 979mm 1,6kg
con binario elettrificato per micromen ottone ap-s frame without shelf electrified track for micromen 38.5" 3.5lb

Ra	R9	ies tm/30		sdc	Vf	lm/m	W/m	lm/W
95	90	Rf 93	Rg 102	step 2	24	1250	13	96
V0001		5,9 Ta25 °C		vita media · average life		50000 h	L80	B10

micromen 24Vdc

- Vb9.528.55.1** alluminio lucido adattatore nero55 3000K 13° 0,02kg
polished aluminium nero55 adapter 0.04lb
- Vb9.528.56** alluminio lucido adattatore nero55 3000K 25° 0,02kg
polished aluminium nero55 adapter 0.04lb
- Vb9.528.57** nero55 adattatore nero55 3000K 12° 0,02kg
nero55 adapter 0.04lb
- Vb9.528.58** nero55 adattatore nero55 3000K 23° 0,02kg
nero55 adapter 0.04lb

Ra	ies tm-30		sdc	mA	V _{f (min)}	lm	W	lm/W
90	Rf 90	Rg 100	step 2	300	2,8	90	1	90
ca011		les2 Ta25 °C		vita media · average life		50000 h	L80	B10

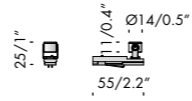

men sola 170x979/04
max 6 micromen

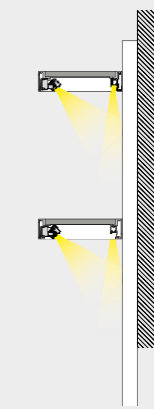
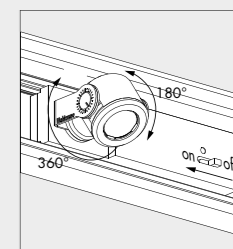
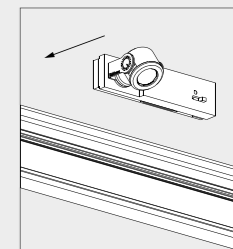
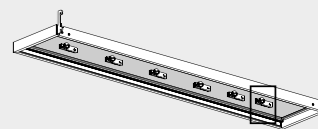

men sole 170x979

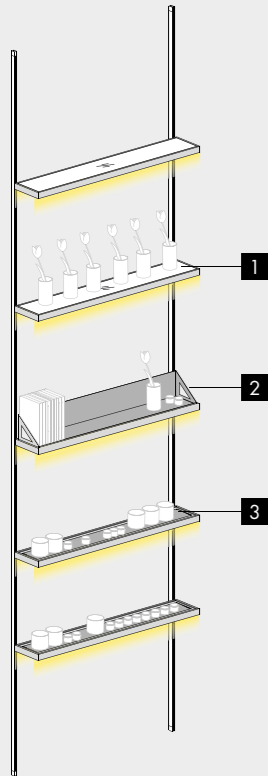

- 1** ripiano vetro extra chiaro
glass shelf extra-clear
- 2** porta oggetti cromo nero
roof black chrome
- 3** porta spezie cromo nero
spices standing black chrome

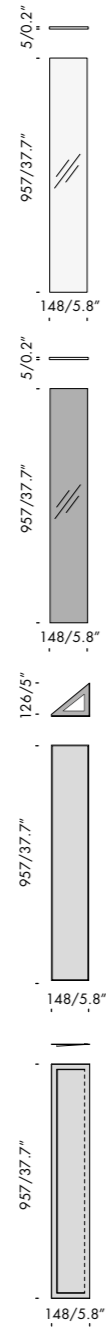

componenti. components.

codice	descrizione	colore	dimensioni	peso
f9.529.70	ripiano vetro glass shelf	extra chiaro extra-clear	957mm 37.7"	1,8kg 4lb
f9.529.70.n	ripiano vetro glass shelf	nero black	957mm 37.7"	2,2kg 4.8lb
f9.529.72	porta oggetti cromo roof chrome	nero black	957mm 37.7"	2,5kg 5.5lb
f9.529.73	porta spezie cromo spices standing chrome	nero black	957mm 37.7"	2,5kg 5.5lb



men sole 333x333/01

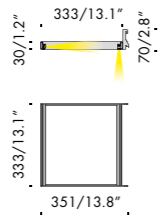
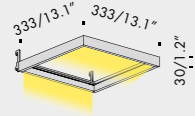

men sole 333x333/01 24Vdc

- Vb6.528.11.2** cornice alluminio lucido senza ripiano 3000K 8,6W 333mm 1kg
polished aluminium frame without shelf 13.1" 2.2lb
- Vb6.528.12.2** cornice nero senza ripiano 3000K 8,6W 333mm 1kg
black frame without shelf 13.1" 2.2lb
- Vb6.528.13** cornice ottone ap-s senza ripiano 3000K 8,6W 333mm 1kg
ottone ap-s frame without shelf 13.1" 2.2lb

Ra	R9	ies tm/30		sdc	Vf	lm/m	W/m	lm/W
95	90	Rf 93	Rg 102	step 2	24	1250	13	96
V0001	5,9	Ta25 °C		vita media · average life		50000 h	L80	B10

men sole 333x333/02

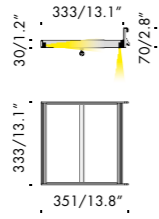
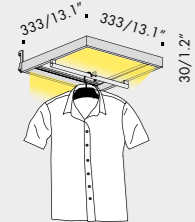

men sole 333x333/02 24Vdc

- Vb6.528.21.2** appendiabiti alluminio lucido 3000K 8,6W 333mm 1,2kg
senza ripiano polished aluminium clothes hanger
without shelf 13.1" 2.6lb
- Vb6.528.22.2** appendiabiti nero senza ripiano 3000K 8,6W 333mm 1,2kg
black clothes hanger without shelf 13.1" 2.6lb
- Vb6.528.23** appendiabiti ottone ap-s senza ripiano 3000K 8,6W 333mm 1,2kg
ottone ap-s clothes hanger without shelf 13.1" 2.6lb

Ra	R9	ies tm/30		sdc	Vf	lm/m	W/m	lm/W
95	90	Rf 93	Rg 102	step 2	24	1250	13	96
V0001	5,9	Ta25 °C		vita media · average life		50000 h	L80	B10

men sole 333x333/03

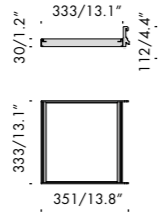
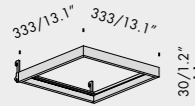

men sole 333x333/03

- f6.528.31.2** cornice cieca alluminio lucido senza ripiano 333mm 1kg
polished aluminium blind frame without shelf 13.1" 2.2lb
- f6.528.32.2** cornice cieca nero senza ripiano 333mm 1kg
black blind frame without shelf 13.1" 2.2lb
- Vb6.528.33** cornice cieca ottone ap-s senza ripiano 333mm 1kg
ottone ap-s blind frame without shelf 13.1" 2.2lb

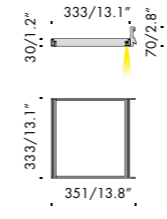

men sole 333x333/04 24Vdc

- f6.528.111** cornice alluminio lucido senza ripiano 3000K 4,3W 333mm 1kg
con binario elettrificato per micromen polished aluminium frame without shelf
electrified track for micromen 13.1" 2.2lb
- f6.528.112** cornice nero senza ripiano 3000K 4,3W 333mm 1kg
con binario elettrificato per micromen black frame without shelf electrified
track for micromen 13.1" 2.2lb
- Vb6.528.113** cornice ottone ap-s senza ripiano 3000K 4,3W 333mm 1kg
con binario elettrificato per micromen ottone ap-s frame without shelf
electrified track for micromen 13.1" 2.2lb

Ra	R9	ies tm/30		sdc	Vf	lm/m	W/m	lm/W
95	90	Rf 93	Rg 102	step 2	24	1250	13	96
V0001	5,9	Ta25 °C		vita media · average life		50000 h	L80	B10

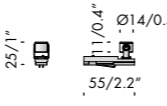

micromen 24Vdc

- Vb9.528.55.1** alluminio lucido adattatore nero55 3000K 13° 0,02kg
polished aluminium nero55 adapter 0.04lb
- Vb9.528.56** alluminio lucido adattatore nero55 3000K 25° 0,02kg
polished aluminium nero55 adapter 0.04lb
- Vb9.528.57** nero55 adattatore nero55 3000K 12° 0,02kg
nero55 adapter 0.04lb
- Vb9.528.58** nero55 adattatore nero55 3000K 23° 0,02kg
nero55 adapter 0.04lb

Ra	ies tm-30		sdc	mA	V _{f(min)}	lm	W	lm/W
90	Rf 90	Rg 100	step 2	300	2,8	90	1	90
ca011	les2 • Ta25 °C		vita media · average life		50000 h	L80	B10	

men sole 333x333/04
max 2 micromen

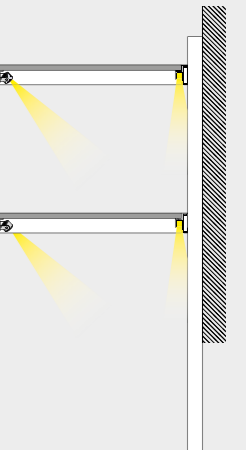
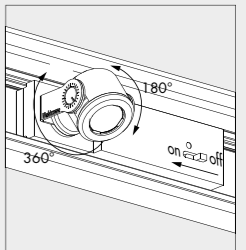
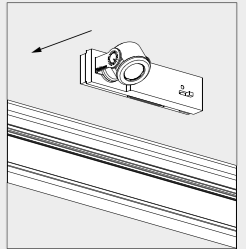
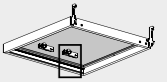

men sole 333x333

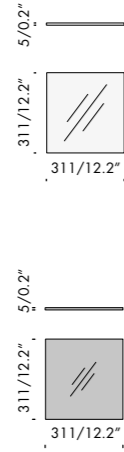
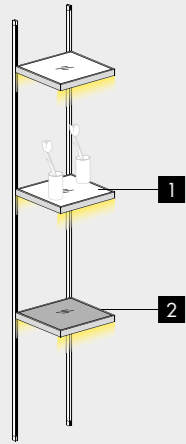

1 ripiano vetro extra chiaro
glass shelf extra-clear

2 porta oggetti cromo nero
roof black chrome

componenti. components.

f9.528.86.1 ripiano vetro
glass shelf extra chiaro
extra-clear 311 mm
12.2" 1,2kg
2.6lb

Vb9.528.86.n ripiano vetro
glass shelf nero
black 311 mm
12.2" 1,4kg
3.1lb



men sole 333x656/01

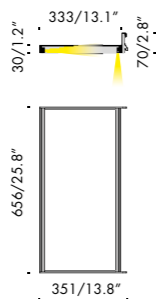
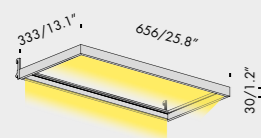

men sole 333x656/02

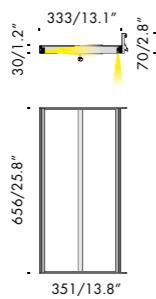
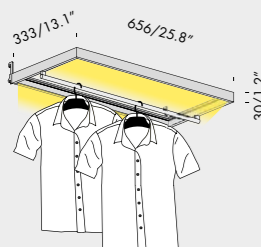

men sole 333x656/03

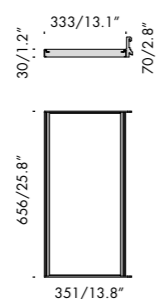
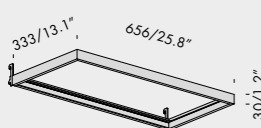

men sole 333x656/01 24Vdc

- Vb6.528.14.2** cornice alluminio lucido senza ripiano 3000K 17W 656mm 1,4kg
polished aluminium frame without shelf 25.8" 3.1lb
- Vb6.528.15.2** cornice nero senza ripiano 3000K 17W 656mm 1,4kg
black frame without shelf 25.8" 3.1lb
- Vb6.528.16** cornice ottone ap-s senza ripiano 3000K 17W 656mm 1,4kg
ottone ap-s frame without shelf 25.8" 3.1lb

Ra	R9	ies tm/30		sdc	Vf	lm/m	W/m	lm/W
95	90	Rf 93	Rg 102	step 2	24	1250	13	96
V0001		5,9 Ta25 °C		vita media · average life		50000 h	L80	B10

men sole 333x656/02 24Vdc

- Vb6.528.24.2** appendiabiti alluminio lucido 3000K 17W 656mm 1,6kg
senza ripiano
polished aluminium clothes hanger
without shelf 25.8" 3.5lb
- Vb6.528.25.2** appendiabiti nero senza ripiano 3000K 17W 656mm 1,6kg
black clothes hanger without shelf 25.8" 3.5lb
- Vb6.528.26** appendiabiti ottone ap-s senza ripiano 3000K 17W 656mm 1,6kg
ottone ap-s clothes hanger without shelf 25.8" 3.5lb

Ra	R9	ies tm/30		sdc	Vf	lm/m	W/m	lm/W
95	90	Rf 93	Rg 102	step 2	24	1250	13	96
V0001		5,9 Ta25 °C		vita media · average life		50000 h	L80	B10

men sole 333x656/03

- f6.528.34.2** cornice cieca alluminio lucido senza ripiano 656mm 1,4kg
polished aluminium blind frame without shelf 25.8" 3.1lb
- f6.528.35.2** cornice cieca nero senza ripiano 656mm 1,4kg
black blind frame without shelf 25.8" 3.1lb
- Vb6.528.36** cornice cieca ottone ap-s senza ripiano 656mm 1,4kg
ottone ap-s blind frame without shelf 25.8" 3.1lb

men sole 333x656/04 24Vdc

- f6.528.114** cornice alluminio lucido senza ripiano 3000K 8,5W 656mm 1,4kg
con binario elettrificato per micromen
polished aluminium frame without shelf
electrified track for micromen 25.8" 3.1lb
- f6.528.115** cornice nero senza ripiano 3000K 8,5W 656mm 1,4kg
con binario elettrificato per micromen
black frame without shelf electrified
track for micromen 25.8" 3.1lb
- Vb6.528.116** cornice ottone ap-s senza ripiano 3000K 8,5W 656mm 1,4kg
con binario elettrificato per micromen
ottone ap-s frame without shelf
electrified track for micromen 25.8" 3.1lb

Ra	R9	ies tm/30		sdc	Vf	lm/m	W/m	lm/W
95	90	Rf 93	Rg 102	step 2	24	1250	13	96
V0001		5,9 Ta25 °C		vita media · average life		50000 h	L80	B10

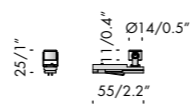

micromen 24Vdc

- Vb9.528.55.1** alluminio lucido adattatore nero55 3000K 13° 0,02kg
polished aluminium nero55 adapter 0.04lb
- Vb9.528.56** alluminio lucido adattatore nero55 3000K 25° 0,02kg
polished aluminium nero55 adapter 0.04lb
- Vb9.528.57** nero55 adattatore nero55 3000K 12° 0,02kg
nero55 adapter 0.04lb
- Vb9.528.58** nero55 adattatore nero55 3000K 23° 0,02kg
nero55 adapter 0.04lb

Ra	ies tm-30		sdc	mA	V _{f (min)}	lm	W	lm/W
90	Rf 90	Rg 100	step 2	300	2,8	90	1	90
ca011		les2 Ta25 °C		vita media · average life		50000 h	L80	B10

men sole 333x656/04
max 4 micromen

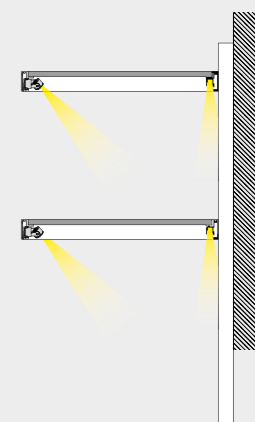
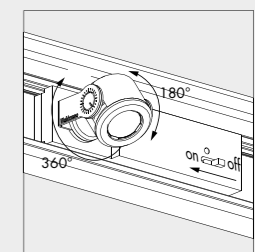
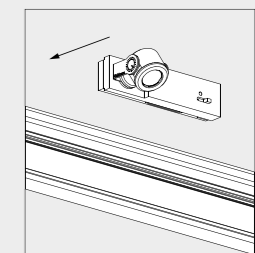
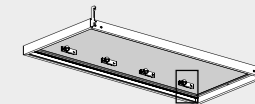

men sole 333x656

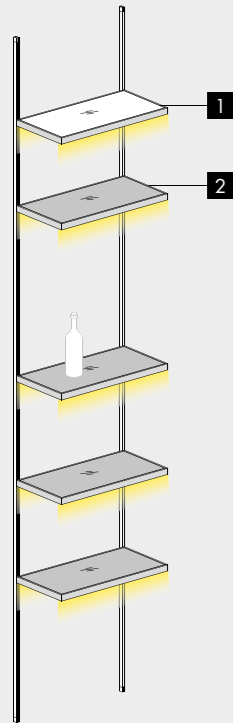

1 ripiano vetro extra chiaro
glass shelf extra-clear

2 ripiano vetro nero
glass shelf black

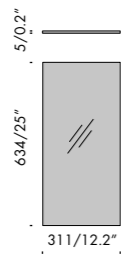

componenti. components.

f9.528.87.1 ripiano vetro
glass shelf extra chiaro
extra-clear 634mm
25" 2,4kg
5.3lb

Vb9.528.87.n ripiano vetro
glass shelf nero
black 634mm
25" 2,9kg
6.4lb



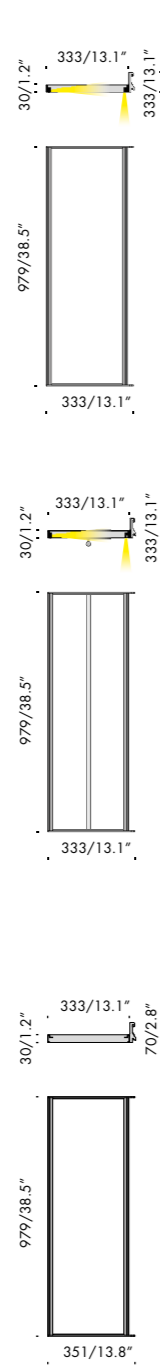

men sole 333x979/01 24Vdc

- Vb6.528.17.2** cornice alluminio lucido senza ripiano 3000K 26W 979mm 1,8kg
polished aluminium frame without shelf 38.5" 4lb
- Vb6.528.18.2** cornice nero senza ripiano 3000K 26W 979mm 1,8kg
black frame without shelf 38.5" 4lb
- Vb6.528.19** cornice ottone ap-s senza ripiano 3000K 26W 979mm 1,8kg
ottone ap-s frame without shelf 38.5" 4lb

Ra	R9	ies tm/30		sdc	Vf	lm/m	W/m	lm/W
95	90	Rf 93	Rg 102	step 2	24	1250	13	96
V0001		5,9 Ta25 °C		vita media · average life		50000 h	L80	B10

men sole 333x979/02 24Vdc

- Vb6.528.27.2** appendiabiti alluminio lucido 3000K 26W 979mm 2,2kg
senza ripiano 38.5" 4.8lb
polished aluminium clothes hanger without shelf
- Vb6.528.28.2** appendiabiti nero senza ripiano 3000K 26W 979mm 2,2kg
black clothes hanger without shelf 38.5" 4.8lb
- Vb6.528.29** appendiabiti ottone ap-s senza ripiano 3000K 26W 979mm 2,2kg
ottone ap-s clothes hanger without shelf 38.5" 4.8lb

Ra	R9	ies tm/30		sdc	Vf	lm/m	W/m	lm/W
95	90	Rf 93	Rg 102	step 2	24	1250	13	96
V0001		5,9 Ta25 °C		vita media · average life		50000 h	L80	B10

men sole 333x979/03

- f6.528.37.2** cornice cieca alluminio lucido senza ripiano 979mm 1,8kg
polished aluminium blind frame without shelf 38.5" 4lb
- f6.528.38.2** cornice cieca nero senza ripiano 979mm 1,8kg
black blind frame without shelf 38.5" 4lb
- Vb6.528.39** cornice cieca ottone ap-s senza ripiano 979mm 1,8kg
ottone ap-s blind frame without shelf 38.5" 4lb

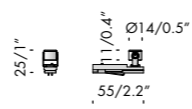
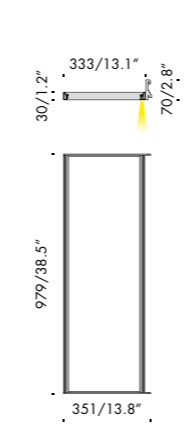

men sole 333x979/04 24Vdc

- f6.528.117** cornice alluminio lucido senza ripiano 3000K 13W 979mm 1,8kg
con binario elettrificato per micromen 38.5" 4lb
polished aluminium frame without shelf electrified track for micromen
- f6.528.118** cornice nero senza ripiano 3000K 13W 979mm 1,8kg
con binario elettrificato per micromen 38.5" 4lb
black frame without shelf electrified track for micromen
- Vb6.528.119** cornice ottone ap-s senza ripiano 3000K 13W 979mm 1,8kg
con binario elettrificato per micromen 38.5" 4lb
ottone ap-s frame without shelf electrified track for micromen

Ra	R9	ies tm/30		sdc	Vf	lm/m	W/m	lm/W
95	90	Rf 93	Rg 102	step 2	24	1250	13	96
V0001		5,9 Ta25 °C		vita media · average life		50000 h	L80	B10

micromen 24Vdc

- Vb9.528.55.1** alluminio lucido adattatore nero55 3000K 13° 0,02kg
polished aluminium nero55 adapter 0.04lb
- Vb9.528.56** alluminio lucido adattatore nero55 3000K 25° 0,02kg
polished aluminium nero55 adapter 0.04lb
- Vb9.528.57** nero55 adattatore nero55 3000K 12° 0,02kg
nero55 adapter 0.04lb
- Vb9.528.58** nero55 adattatore nero55 3000K 23° 0,02kg
nero55 adapter 0.04lb

Ra	ies tm-30		sdc	mA	V _{f(min)}	lm	W	lm/W
90	Rf 90	Rg 100	step 2	300	2,8	90	1	90
ca011		les2 • Ta25 °C		vita media · average life		50000 h	L80	B10

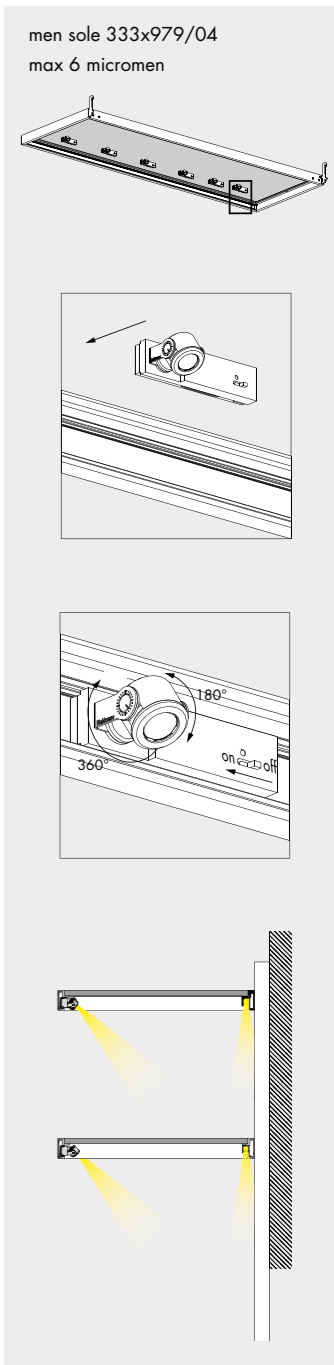

men sole 333x979

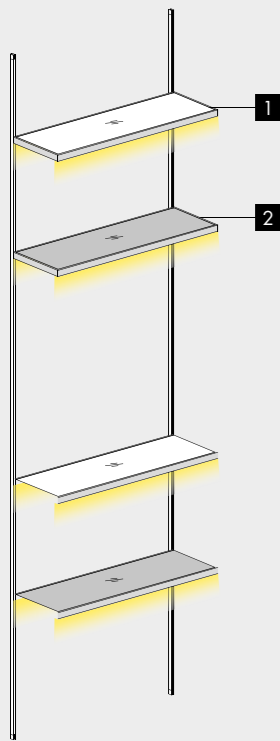

1 ripiano vetro extra chiaro
glass shelf extra-clear

2 ripiano vetro nero
glass shelf black

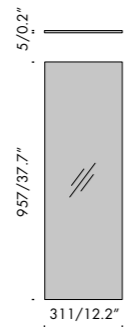

componenti. components.

f9.528.88.1 ripiano vetro
glass shelf extra chiaro
extra-clear 957mm
37.7" 3,6kg
7.9lb

Vb9.528.88.n ripiano vetro
glass shelf nero
black 957mm
37.7" 4,4kg
9.7lb

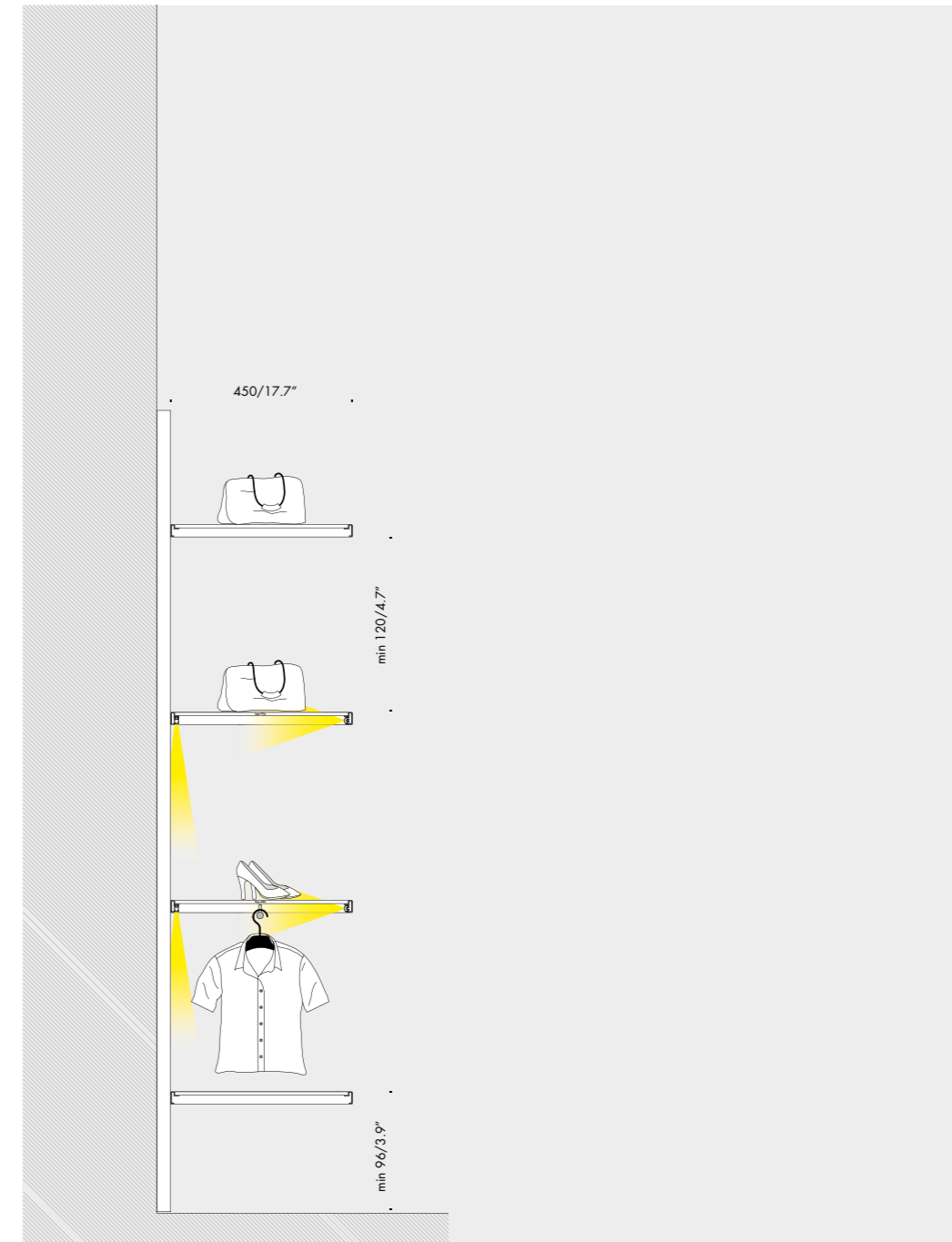

men sole 450x333/01

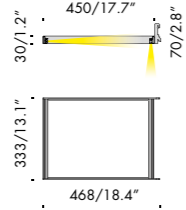
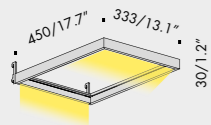

men sole 450x333/02

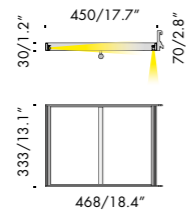
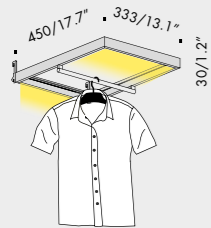

men sole 450x333/03

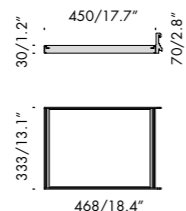
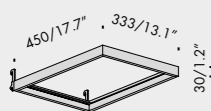

men sole 450x333/01 24Vdc

- Vb7.528.11.2** cornice alluminio lucido senza ripiano 3000K 8,6W 333mm 1,1kg
polished aluminium frame without shelf 13.1" 2.4lb
- Vb7.528.12.2** cornice nero senza ripiano 3000K 8,6W 333mm 1,1kg
black frame without shelf 13.1" 2.4lb
- Vb7.528.10** cornice ottone ap-s senza ripiano 3000K 8,6W 333mm 1,1kg
ottone ap-s frame without shelf 13.1" 2.4lb

Ra	R9	ies tm/30		sdcm	Vf	lm/m	W/m	lm/W
95	90	Rf 93	Rg 102	step 2	24	1250	13	96
V0001		5,9	Ta25 °C		vita media · average life		50000 h	L80 B10

men sole 450x333/02 24Vdc

- Vb7.528.21.2** appendiabiti alluminio lucido 3000K 8,6W 333mm 1,2kg
senza ripiano polished aluminium clothes hanger
without shelf 13.1" 2.6lb
- Vb7.528.22.2** appendiabiti nero senza ripiano 3000K 8,6W 333mm 1,2kg
black clothes hanger without shelf 13.1" 2.6lb
- Vb7.528.20** appendiabiti ottone ap-s senza ripiano 3000K 8,6W 333mm 1,2kg
ottone ap-s clothes hanger without shelf 13.1" 2.6lb

Ra	R9	ies tm/30		sdcm	Vf	lm/m	W/m	lm/W
95	90	Rf 93	Rg 102	step 2	24	1250	13	96
V0001		5,9	Ta25 °C		vita media · average life		50000 h	L80 B10

men sole 450x333/03

- f7.528.31.2** cornice cieca alluminio lucido senza ripiano 333mm 1,1kg
polished aluminium blind frame without shelf 13.1" 2.4lb
- f7.528.32.2** cornice cieca nero senza ripiano 333mm 1,1kg
black blind frame without shelf 13.1" 2.4lb
- Vb7.528.30** cornice cieca ottone ap-s senza ripiano 333mm 1,1kg
ottone ap-s blind frame without shelf 13.1" 2.4lb

men sole 450x333/04 24Vdc

- Vb7.528.61** cornice alluminio lucido senza ripiano 3000K 4,3W 333mm 1,1kg
con binario elettrificato per micromen polished aluminium frame without shelf
electrified track for micromen 13.1" 2.4lb
- Vb7.528.62** cornice nero senza ripiano 3000K 4,3W 333mm 1,1kg
con binario elettrificato per micromen black frame without shelf electrified track
for micromen 13.1" 2.4lb
- Vb7.528.63** cornice ottone ap-s senza ripiano 3000K 4,3W 333mm 1,1kg
con binario elettrificato per micromen ottone ap-s frame without shelf
electrified track for micromen 13.1" 2.4lb

Ra	R9	ies tm/30		sdcm	Vf	lm/m	W/m	lm/W
95	90	Rf 93	Rg 102	step 2	24	1250	13	96
V0001		5,9	Ta25 °C		vita media · average life		50000 h	L80 B10

micromen 24Vdc

- Vb9.528.55.1** alluminio lucido adattatore nero55 3000K 13° 0,02kg
polished aluminium nero55 adapter 0.04lb
- Vb9.528.56** alluminio lucido adattatore nero55 3000K 25° 0,02kg
polished aluminium nero55 adapter 0.04lb
- Vb9.528.57** nero55 adattatore nero55 3000K 12° 0,02kg
nero55 adapter 0.04lb
- Vb9.528.58** nero55 adattatore nero55 3000K 23° 0,02kg
nero55 adapter 0.04lb

Ra	ies tm-30		sdcm	mA	V _{f(min)}	lm	W	lm/W
90	Rf 90	Rg 100	step 2	300	2,8	90	1	90
ca011		les2	Ta25 °C		vita media · average life		50000 h	L80 B10

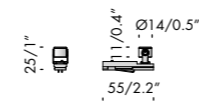
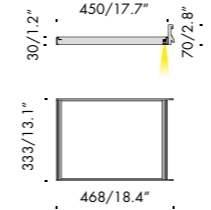

men sole 450x333/04
max 2 micromen

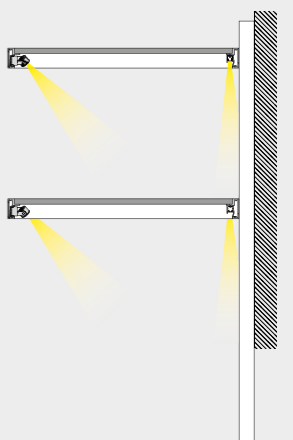
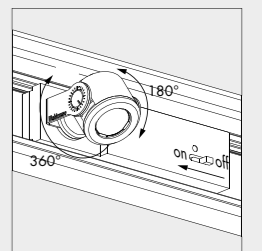
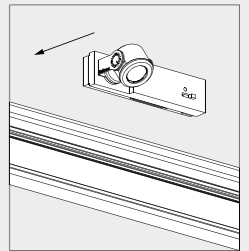
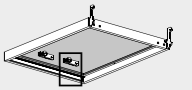

men sole 450x333

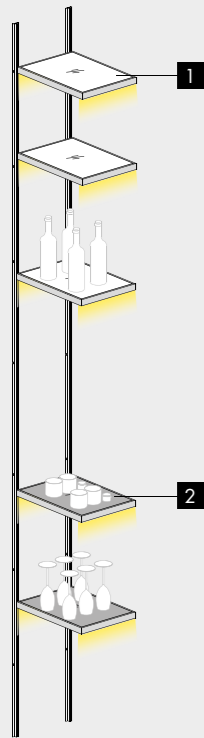

1 ripiano vetro extra chiaro
glass shelf extra-clear

2 ripiano vetro nero
black glass shelf

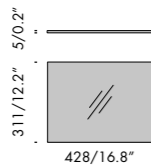
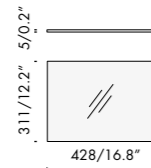

componenti. components.

f9.528.96.1 ripiano vetro
glass shelf extra chiaro
extra-clear 311mm
12.2" 1,6kg
3.5lb

Vb9.528.96.n ripiano vetro
glass shelf nero
black 311mm
12.2" 1,9kg
4.2lb



men sole 450x510/01

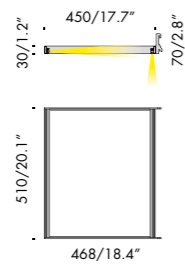
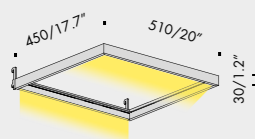

men sole 450x510/02

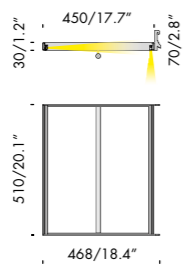
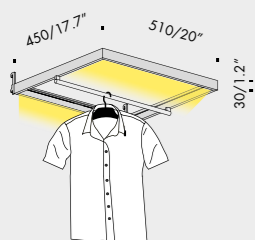

men sole 450x510/03

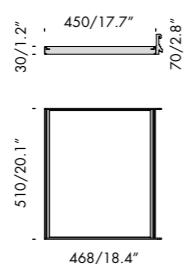
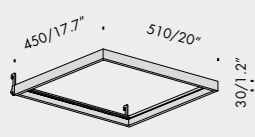

men sole 450x510/01 24Vdc

- Vb7.528.13.2** cornice alluminio lucido senza ripiano 3000K 13W 510mm 1,4kg
polished aluminium frame without shelf 20.1" 3.1lb
- Vb7.528.14.2** cornice nero senza ripiano 3000K 13W 510mm 1,4kg
black frame without shelf 20.1" 3.1lb
- Vb7.528.19** cornice ottone ap-s senza ripiano 3000K 13W 510mm 1,4kg
ottone ap-s frame without shelf 20.1" 3.1lb

Ra	R9	ies tm/30		sdc	Vf	lm/m	W/m	lm/W
95	90	Rf 93	Rg 102	step 2	24	1250	13	96
V0001		5,9 Ta25 °C		vita media · average life		50000 h	L80	B10

men sole 450x510/02 24Vdc

- Vb7.528.23.2** appendiabiti alluminio lucido 3000K 13W 510mm 1,6kg
senza ripiano polished aluminium clothes hanger without shelf 20.1" 3.5lb
- Vb7.528.24.2** appendiabiti nero senza ripiano 3000K 13W 510mm 1,6kg
black clothes hanger without shelf 20.1" 3.5lb
- Vb7.528.29** appendiabiti ottone ap-s senza ripiano 3000K 13W 510mm 1,6kg
ottone ap-s clothes hanger without shelf 20.1" 3.5lb

Ra	R9	ies tm/30		sdc	Vf	lm/m	W/m	lm/W
95	90	Rf 93	Rg 102	step 2	24	1250	13	96
V0001		5,9 Ta25 °C		vita media · average life		50000 h	L80	B10

men sole 450x510/03

- f7.528.33.2** cornice cieca alluminio lucido senza ripiano 510mm 1,4kg
polished aluminium blind frame without shelf 20.1" 3.1lb
- f7.528.34.2** cornice cieca nero senza ripiano 510mm 1,4kg
black blind frame without shelf 20.1" 3.1lb
- Vb7.528.39** appendiabiti ottone ap-s senza ripiano 510mm 1,4kg
ottone ap-s blind frame without shelf 20.1" 3.1lb

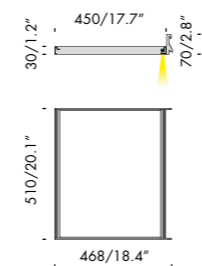

men sole 450x510/04 24Vdc

- Vb7.528.71** cornice alluminio lucido senza ripiano 3000K 6,5W 510mm 1,4kg
con binario elettrificato per micromen polished aluminium frame without shelf electrified track for micromen 20.1" 3.1lb
- Vb7.528.72** cornice nero senza ripiano 3000K 6,5W 510mm 1,4kg
con binario elettrificato per micromen black frame without shelf electrified track for micromen 20.1" 3.1lb
- Vb7.528.73** cornice ottone ap-s senza ripiano 3000K 6,5W 510mm 1,4kg
con binario elettrificato per micromen ottone ap-s frame without shelf electrified track for micromen 20.1" 3.1lb

Ra	R9	ies tm/30		sdc	Vf	lm/m	W/m	lm/W
95	90	Rf 93	Rg 102	step 2	24	1250	13	96
V0001		5,9 Ta25 °C		vita media · average life		50000 h	L80	B10

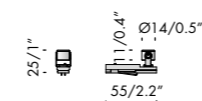

micromen 24Vdc

- Vb9.528.55.1** alluminio lucido adattatore nero55 3000K 13° 0,02kg
polished aluminium nero55 adapter 0.04lb
- Vb9.528.56** alluminio lucido adattatore nero55 3000K 25° 0,02kg
polished aluminium nero55 adapter 0.04lb
- Vb9.528.57** nero55 adattatore nero55 3000K 12° 0,02kg
nero55 adapter 0.04lb
- Vb9.528.58** nero55 adattatore nero55 3000K 23° 0,02kg
nero55 adapter 0.04lb

Ra	ies tm-30		sdc	mA	V _{f(min)}	lm	W	lm/W
90	Rf 90	Rg 100	step 2	300	2,8	90	1	90
ca011		les2 Ta25 °C		vita media · average life		50000 h	L80	B10

men sole 450x510/04
max 2 micromen

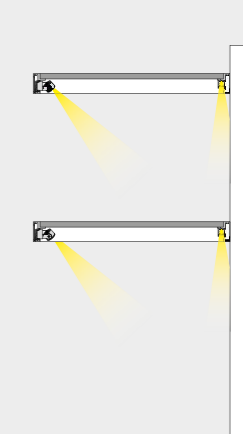
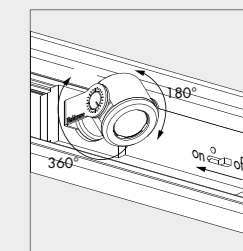
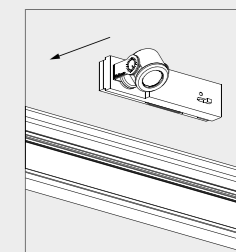
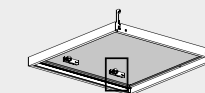

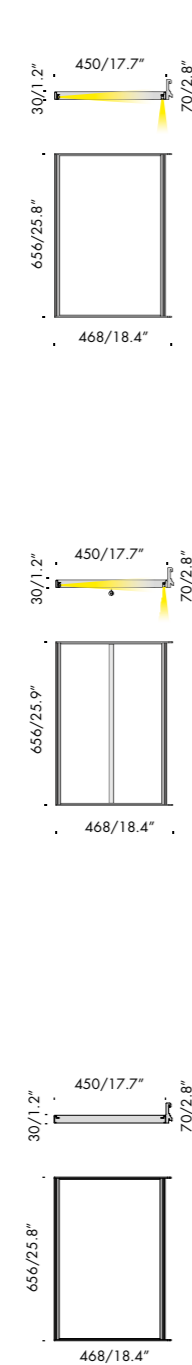
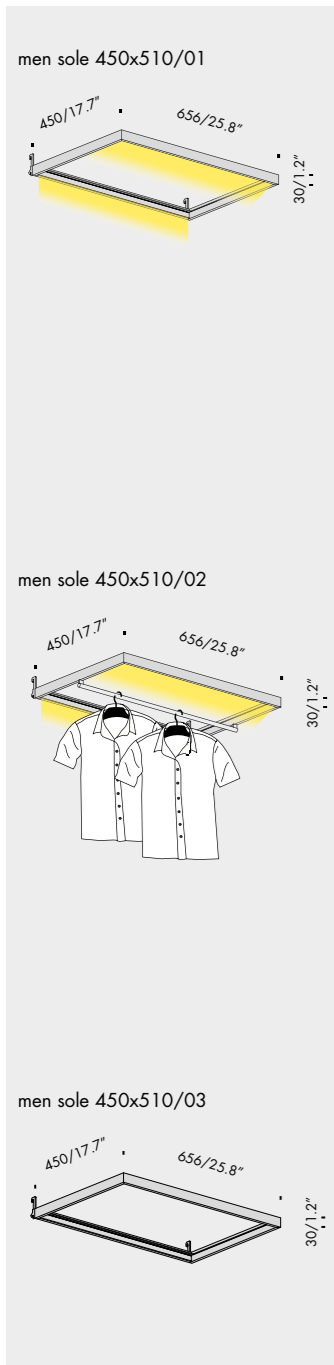

men sole 450x656/01 24Vdc

- Vb7.528.15.2** cornice alluminio lucido senza ripiano 3000K 17W 656mm 1,5kg
polished aluminium frame without shelf 25.8" 3.3lb
- Vb7.528.16.2** cornice nero senza ripiano 3000K 17W 656mm 1,5kg
black frame without shelf 25.8" 3.3lb
- Vb7.528.101** cornice ottone ap-s senza ripiano 3000K 17W 656mm 1,5kg
ottone ap-s frame without shelf 25.8" 3.3lb

Ra	R9	ies tm/30		sdc	Vf	lm/m	W/m	lm/W
95	90	Rf 93	Rg 102	step 2	24	1250	13	96
V0001		5,9		Ta25 °C		vita media · average life		50000 h L80 B10

men sole 450x656/02 24Vdc

- Vb7.528.25.2** appendiabiti alluminio lucido 3000K 17W 656mm 1,8kg
senza ripiano 25.8" 4lb
polished aluminium clothes hanger without shelf
- Vb7.528.26.2** appendiabiti nero senza ripiano 3000K 17W 656mm 1,8kg
black clothes hanger without shelf 25.8" 4lb
- Vb7.528.102** appendiabiti ottone ap-s senza ripiano 3000K 17W 656mm 1,8kg
ottone ap-s clothes hanger without shelf 25.8" 4lb

Ra	R9	ies tm/30		sdc	Vf	lm/m	W/m	lm/W
95	90	Rf 93	Rg 102	step 2	24	1250	13	96
V0001		5,9		Ta25 °C		vita media · average life		50000 h L80 B10

men sole 450x656/03

- f7.528.35.2** cornice cieca alluminio lucido senza ripiano 656mm 1,5kg
polished aluminium blind frame without shelf 25.8" 3.3lb
- f7.528.36.2** cornice cieca nero senza ripiano 656mm 1,5kg
black blind frame without shelf 25.8" 3.3lb
- Vb7.528.103** cornice cieca ottone ap-s senza ripiano 656mm 1,5kg
ottone ap-s blind frame without shelf 25.8" 3.3lb

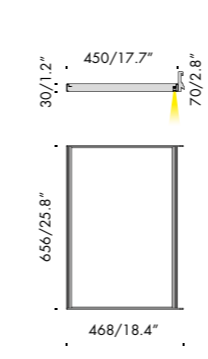

men sole 450x656/04 24Vdc

- Vb7.528.58** cornice alluminio lucido senza ripiano 3000K 8,5W 656mm 1,5kg
con binario elettrificato per micromen 25.8" 3.3lb
polished aluminium frame without shelf electrified track for micromen
- Vb7.528.59** cornice nero senza ripiano 3000K 8,5W 656mm 1,5kg
con binario elettrificato per micromen 25.8" 3.3lb
black frame without shelf electrified track for micromen
- Vb7.528.60** cornice ottone ap-s senza ripiano 3000K 8,5W 656mm 1,5kg
con binario elettrificato per micromen 25.8" 3.3lb
ottone ap-s frame without shelf electrified track for micromen

Ra	R9	ies tm/30		sdc	Vf	lm/m	W/m	lm/W
95	90	Rf 93	Rg 102	step 2	24	1250	13	96
V0001		5,9		Ta25 °C		vita media · average life		50000 h L80 B10

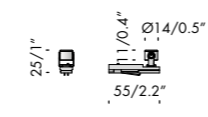

micromen 24Vdc

- Vb9.528.55.1** alluminio lucido adattatore nero55 3000K 13° 0,02kg
polished aluminium nero55 adapter 0.04lb
- Vb9.528.56** alluminio lucido adattatore nero55 3000K 25° 0,02kg
polished aluminium nero55 adapter 0.04lb
- Vb9.528.57** nero55 adattatore nero55 3000K 12° 0,02kg
nero55 adapter 0.04lb
- Vb9.528.58** nero55 adattatore nero55 3000K 23° 0,02kg
nero55 adapter 0.04lb

Ra	ies tm-30		sdc	mA	V _{f(min)}	lm	W	lm/W
90	Rf 90	Rg 100	step 2	300	2,8	90	1	90
ca011		les2 • Ta25 °C		vita media · average life		50000 h L80 B10		

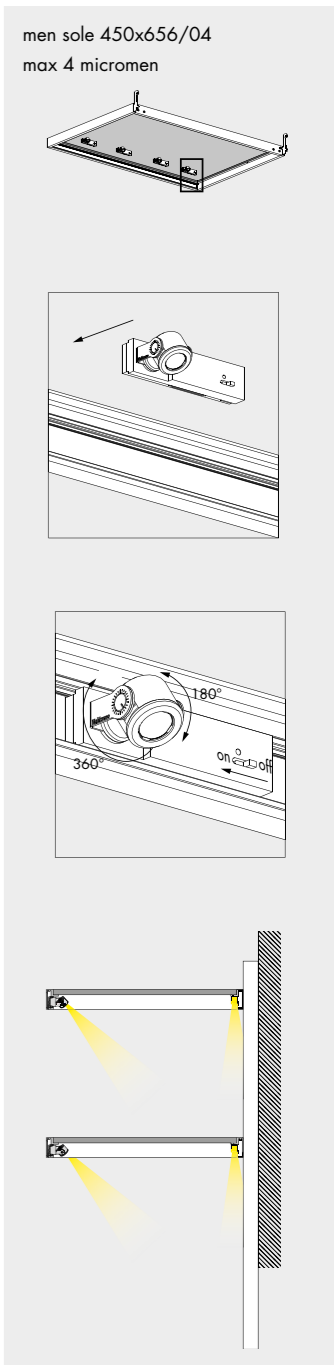

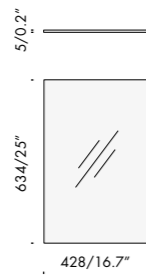

componenti. components.

f9.528.98.1 ripiano vetro
glass shelf extra chiaro
extra-clear 634mm
25" 3,5kg
7.7lb

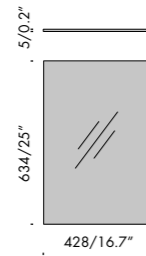

Vb9.528.98.n ripiano vetro
glass shelf nero
black 634mm
25" 4kg
8.8lb



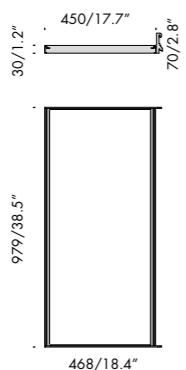
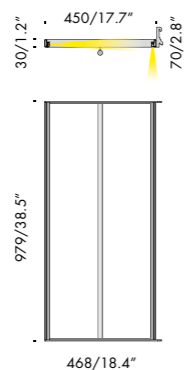
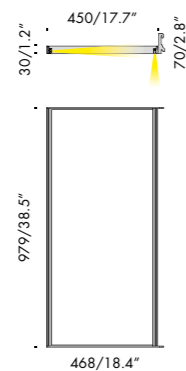
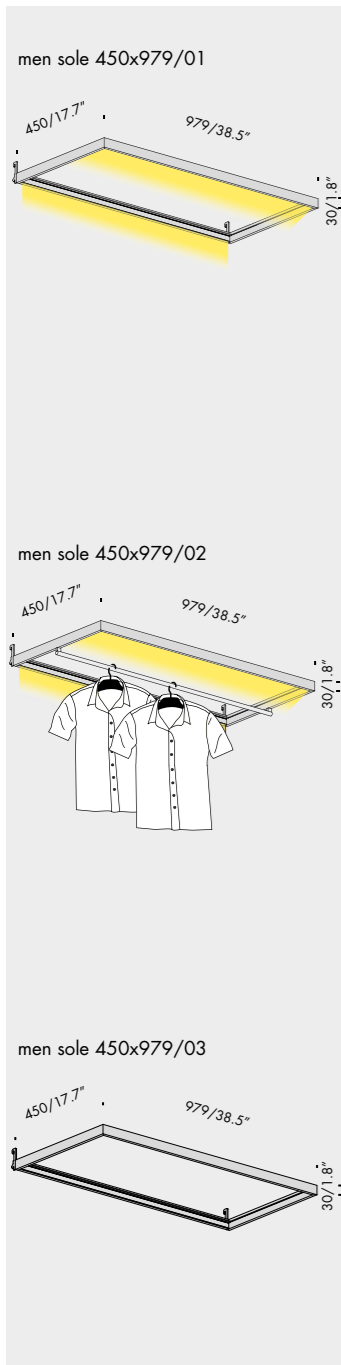

men sole 450x979/01		24Vdc	dry	ⓘ			
Vb7.528.17.2	cornice alluminio lucido senza ripiano polished aluminium frame without shelf	3000K 26W	979mm 2kg 38.5" 4.4lb				
Vb7.528.18.2	cornice nero senza ripiano black frame without shelf	3000K 26W	979mm 2kg 38.5" 4.4lb				
Vb7.528.111	cornice ottone ap-s senza ripiano ottone ap-s frame without shelf	3000K 26W	979mm 2kg 38.5" 4.4lb				
Ra	R9	ies tm/30	sdc	Vf	lm/m	W/m	lm/W
95	90	Rf 93 Rg 102	step 2	24	1250	13	96
V0001	5,9	Ta25 °C	vita media · average life	50000 h	L80	B10	

men sole 450x979/02		24Vdc	dry	ⓘ			
Vb7.528.27.2	appendiabiti alluminio lucido senza ripiano polished aluminium clothes hanger without shelf	3000K 26W	979mm 2,3kg 38.5" 5.1lb				
Vb7.528.28.2	appendiabiti nero senza ripiano black clothes hanger without shelf	3000K 26W	979mm 2,3kg 38.5" 5.1lb				
Vb7.528.112	appendiabiti ottone ap-s senza ripiano ottone ap-s clothes hanger without shelf	3000K 26W	979mm 2,3kg 38.5" 5.1lb				
Ra	R9	ies tm/30	sdc	Vf	lm/m	W/m	lm/W
95	90	Rf 93 Rg 102	step 2	24	1250	13	96
V0001	5,9	Ta25 °C	vita media · average life	50000 h	L80	B10	

men sole 450x979/03		dry	ⓘ
f7.528.37.2	cornice cieca alluminio lucido senza ripiano polished aluminium blind frame without shelf	979mm 2kg 38.5" 4.4lb	
f7.528.38.2	cornice cieca nero senza ripiano black blind frame without shelf	979mm 2kg 38.5" 4.4lb	
Vb7.528.113	cornice cieca ottone ap-s senza ripiano ottone ap-s blind frame without shelf	979mm 2kg 38.5" 4.4lb	

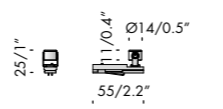
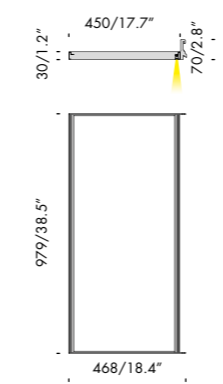

men sole 450x979/04		24Vdc	dry	ⓘ			
Vb7.528.81	cornice alluminio lucido senza ripiano con binario elettrificato per micromen polished aluminium frame without shelf electrified track for micromen	3000K 13W	979mm 2kg 38.5" 4.4lb				
Vb7.528.82	cornice nero senza ripiano con binario elettrificato per micromen black frame without shelf electrified track for micromen	3000K 13W	979mm 2kg 38.5" 4.4lb				
Vb7.528.83	cornice ottone ap-s senza ripiano con binario elettrificato per micromen ottone ap-s frame without shelf electrified track for micromen	3000K 13W	979mm 2kg 38.5" 4.4lb				
Ra	R9	ies tm/30	sdc	Vf	lm/m	W/m	lm/W
95	90	Rf 93 Rg 102	step 2	24	1250	13	96
V0001	5,9	Ta25 °C	vita media · average life	50000 h	L80	B10	

micromen		24Vdc	dry	ⓘ			
Vb9.528.55.1	alluminio lucido polished aluminium	adattatore nero55 nero55 adapter	3000K 13°	0,02kg 0.04lb			
Vb9.528.56	alluminio lucido polished aluminium	adattatore nero55 nero55 adapter	3000K 25°	0,02kg 0.04lb			
Vb9.528.57	nero55	adattatore nero55 nero55 adapter	3000K 12°	0,02kg 0.04lb			
Vb9.528.58	nero55	adattatore nero55 nero55 adapter	3000K 23°	0,02kg 0.04lb			
Ra	ies tm-30	sdc	mA	V _{f(min)}	lm	W	lm/W
90	Rf 90 Rg 100	step 2	300	2,8	90	1	90
ca011	les2	Ta25 °C	vita media · average life	50000 h	L80	B10	

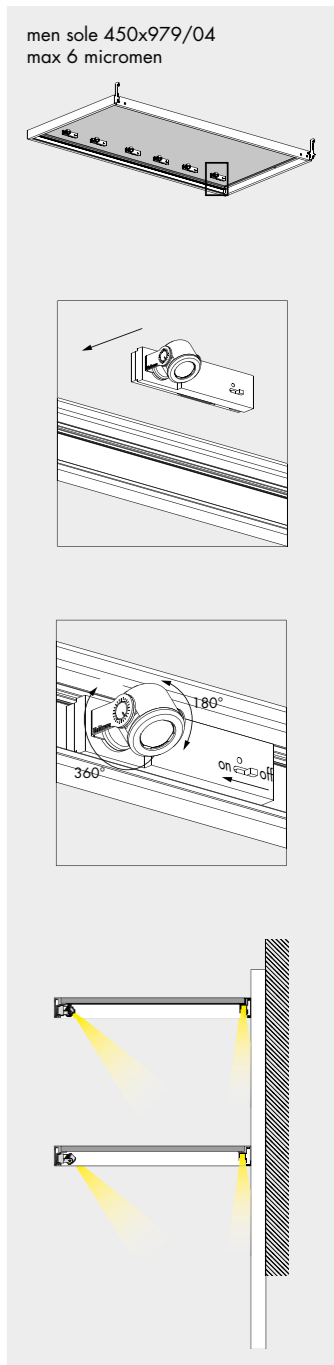

men sole 450x979

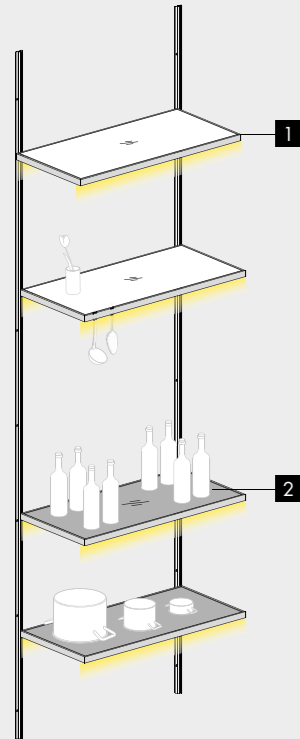

1 ripiano vetro extra chiaro
glass shelf extra-clear

2 ripiano vetro nero
black glass shelf



componenti. components.

f9.528.99.1 ripiano vetro
glass shelf extra chiaro
extra-clear 957mm
37.7" 4,8kg
10.6lb

Vb9.528.99.n ripiano vetro
glass shelf nero
black 957mm
37.7" 5,5kg
12.1lb



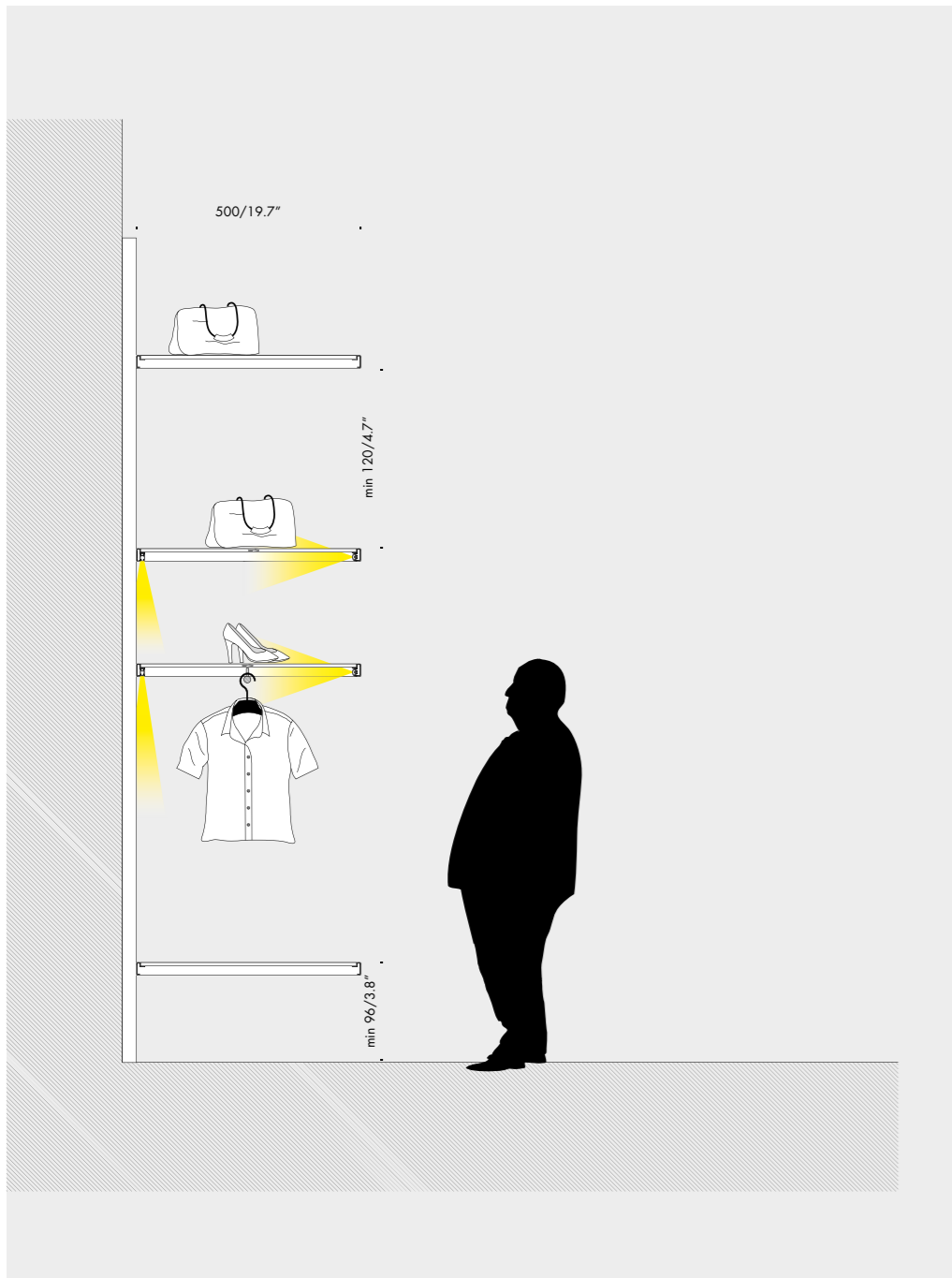

men sole 500x333/01

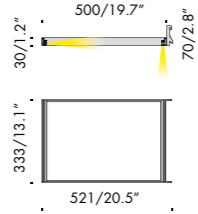
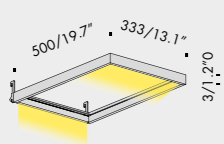

men sole 500x333/02

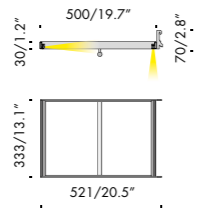
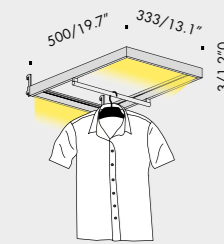

men sole 500x333/03

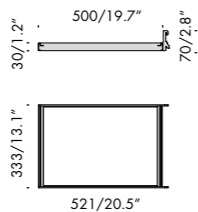
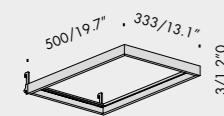

men sole 500x333/01 24Vdc

- f7.528.40.2** cornice alluminio lucido senza ripiano 3000K 8,6W 333mm 1,2kg
polished aluminium frame without shelf 13.1" 2.6lb
- f7.528.41.2** cornice nero senza ripiano 3000K 8,6W 333mm 1,2kg
black frame without shelf 13.1" 2.6lb
- Vb7.528.121** cornice ottone ap-s senza ripiano 3000K 8,6W 333mm 1,2kg
ottone ap-s frame without shelf 13.1" 2.6lb

Ra	R9	ies tm/30		sdc	Vf	lm/m	W/m	lm/W
95	90	Rf 93	Rg 102	step 2	24	1250	13	96
V0001	5,9	Ta25 °C		vita media · average life		50000 h	L80	B10

men sole 500x333/02 24Vdc

- f7.528.42.2** appendiabiti alluminio lucido 3000K 8,6W 333mm 1,3kg
senza ripiano polished aluminium clothes hanger
without shelf 13.1" 2.9lb
- f7.528.43.2** appendiabiti nero senza ripiano 3000K 8,6W 333mm 1,3kg
black clothes hanger without shelf 13.1" 2.9lb
- Vb7.528.122** appendiabiti ottone ap-s senza ripiano 3000K 8,6W 333mm 1,3kg
ottone ap-s clothes hanger without shelf 13.1" 2.9lb

Ra	R9	ies tm/30		sdc	Vf	lm/m	W/m	lm/W
95	90	Rf 93	Rg 102	step 2	24	1250	13	96
V0001	5,9	Ta25 °C		vita media · average life		50000 h	L80	B10

men sole 500x333/03

- f7.528.44.2** cornice cieca alluminio lucido senza ripiano 333mm 1,2kg
polished aluminium blind frame without shelf 13.1" 2.6lb
- f7.528.45.2** cornice cieca nero senza ripiano 333mm 1,2kg
black blind frame without shelf 13.1" 2.6lb
- Vb7.528.123** cornice cieca ottone ap-s senza ripiano 333mm 1,2kg
ottone ap-s blind frame without shelf 13.1" 2.6lb

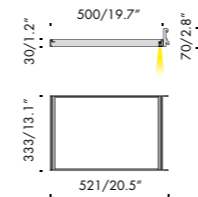

men sole 500x333/04 24Vdc

- Vb7.528.86** cornice alluminio lucido senza ripiano 3000K 4,3W 333mm 1,2kg
con binario elettrificato per micromen polished aluminium frame without shelf
electrified track for micromen 13.1" 2.6lb
- Vb7.528.87** cornice nero senza ripiano 3000K 4,3W 333mm 1,2kg
con binario elettrificato per micromen black frame without shelf electrified
track for micromen 13.1" 2.6lb
- Vb7.528.88** cornice ottone ap-s senza ripiano 3000K 4,3W 333mm 1,2kg
con binario elettrificato per micromen ottone ap-s frame without shelf
electrified track for micromen 13.1" 2.6lb

Ra	R9	ies tm/30		sdc	Vf	lm/m	W/m	lm/W
95	90	Rf 93	Rg 102	step 2	24	1250	13	96
V0001	5,9	Ta25 °C		vita media · average life		50000 h	L80	B10

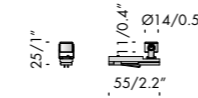

micromen 24Vdc

- Vb9.528.55.1** alluminio lucido adattatore nero55 3000K 13° 0,02kg
polished aluminium nero55 adapter 0.04lb
- Vb9.528.56** alluminio lucido adattatore nero55 3000K 25° 0,02kg
polished aluminium nero55 adapter 0.04lb
- Vb9.528.57** nero55 adattatore nero55 3000K 12° 0,02kg
nero55 adapter 0.04lb
- Vb9.528.58** nero55 adattatore nero55 3000K 23° 0,02kg
nero55 adapter 0.04lb

Ra	ies tm-30		sdc	mA	V _{f(min)}	lm	W	lm/W
90	Rf 90	Rg 100	step 2	300	2,8	90	1	90
ca011	les2 • Ta25 °C		vita media · average life		50000 h	L80	B10	

men sole 500x333/04
max 2 micromen

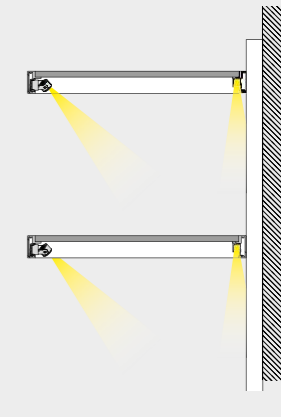
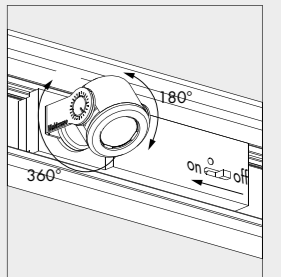
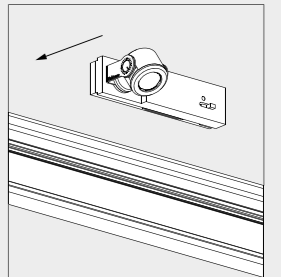
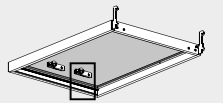

men sole 500x333

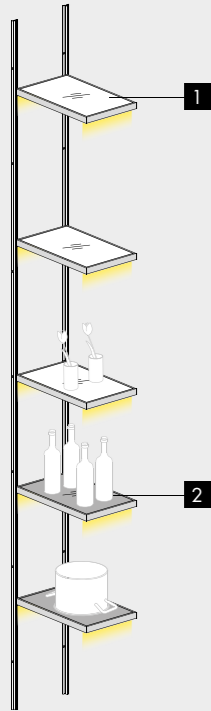

1 ripiano vetro extra chiaro
glass shelf extra-clear

2 ripiano vetro nero
black glass shelf

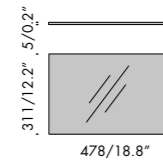
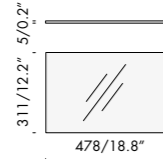

componenti. components.

f9.528.77 ripiano vetro
glass shelf extra chiaro
extra-clear 311 mm
12.2" 1,8kg
4lb

Vb9.528.77.n ripiano vetro
glass shelf nero
black 311 mm
12.2" 2,2kg
4.8lb



men sole 500x656/01

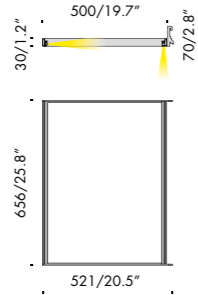
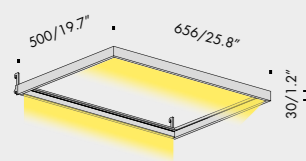

men sole 500x656/02

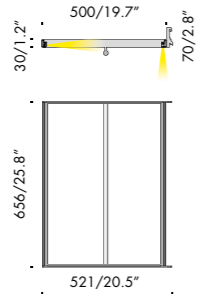
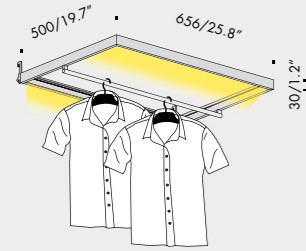

men sole 500x656/03

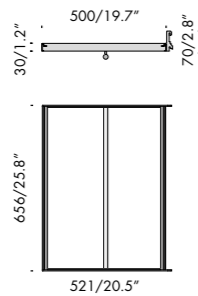
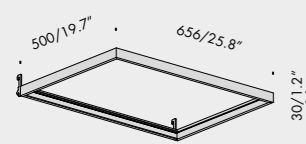

men sole 500x656/01 24Vdc

- Vb7.528.46.2** cornice alluminio lucido senza ripiano 3000K 17W 656mm 1,6kg
polished aluminium frame without shelf 25.8" 3.5lb
- Vb7.528.47.2** cornice nero senza ripiano 3000K 17W 656mm 1,6kg
black frame without shelf 25.8" 3.5lb
- Vb7.528.131** cornice ottone ap-s senza ripiano 3000K 17W 656mm 1,6kg
ottone ap-s frame without shelf 25.8" 3.5lb

Ra	R9	ies tm/30		sdc	Vf	lm/m	W/m	lm/W
95	90	Rf 93	Rg 102	step 2	24	1250	13	96
V0001		5,9 Ta25 °C		vita media · average life		50000 h	L80	B10

men sole 500x656/02 24Vdc

- Vb7.528.48.2** appendiabiti alluminio lucido 3000K 17W 656mm 1,8kg
senza ripiano polished aluminium clothes hanger
without shelf 25.8" 4lb
- Vb7.528.49.2** appendiabiti nero senza ripiano 3000K 17W 656mm 1,8kg
black clothes hanger without shelf 25.8" 4lb
- Vb7.528.132** appendiabiti ottone ap-s senza ripiano 3000K 17W 656mm 1,8kg
ottone ap-s clothes hanger without shelf 25.8" 4lb

Ra	R9	ies tm/30		sdc	Vf	lm/m	W/m	lm/W
95	90	Rf 93	Rg 102	step 2	24	1250	13	96
V0001		5,9 Ta25 °C		vita media · average life		50000 h	L80	B10

men sole 500x656/03

- f7.528.50.2** cornice cieca alluminio lucido senza ripiano 656mm 1,6kg
polished aluminium blind frame without shelf 25.8" 3.5lb
- f7.528.51.2** cornice cieca nero senza ripiano 656mm 1,6kg
black blind frame without shelf 25.8" 3.5lb
- Vb7.528.133** cornice cieca ottone ap-s senza ripiano 656mm 1,6kg
ottone ap-s blind frame without shelf 25.8" 3.5lb

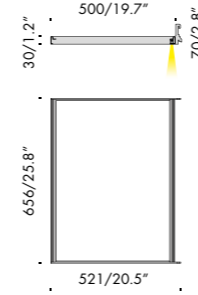

men sole 500x656/04 24Vdc

- Vb7.528.91** cornice alluminio lucido senza ripiano 3000K 8,5W 656mm 1,6kg
con binario elettrificato per micromen polished aluminium frame without shelf
electrified track for micromen 25.8" 3.5lb
- Vb7.528.92** cornice nero senza ripiano 3000K 8,5W 656mm 1,6kg
con binario elettrificato per micromen black frame without shelf electrified
track for micromen 25.8" 3.5lb
- Vb7.528.93** cornice ottone ap-s senza ripiano 3000K 8,5W 656mm 1,6kg
con binario elettrificato per micromen ottone ap-s frame without shelf
electrified track for micromen 25.8" 3.5lb

Ra	R9	ies tm/30		sdc	Vf	lm/m	W/m	lm/W
95	90	Rf 93	Rg 102	step 2	24	1250	13	96
V0001		5,9 Ta25 °C		vita media · average life		50000 h	L80	B10

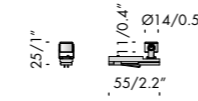

micromen 24Vdc

- Vb9.528.55.1** alluminio lucido adattatore nero55 3000K 13° 0,02kg
polished aluminium nero55 adapter 0.04lb
- Vb9.528.56** alluminio lucido adattatore nero55 3000K 25° 0,02kg
polished aluminium nero55 adapter 0.04lb
- Vb9.528.57** nero55 adattatore nero55 3000K 12° 0,02kg
nero55 adapter 0.04lb
- Vb9.528.58** nero55 adattatore nero55 3000K 23° 0,02kg
nero55 adapter 0.04lb

Ra	ies tm-30		sdc	mA	V _{f(min)}	lm	W	lm/W
90	Rf 90	Rg 100	step 2	300	2,8	90	1	90
ca011		les2 • Ta25 °C		vita media · average life		50000 h	L80	B10

men sole 500x656/04
max 4 micromen

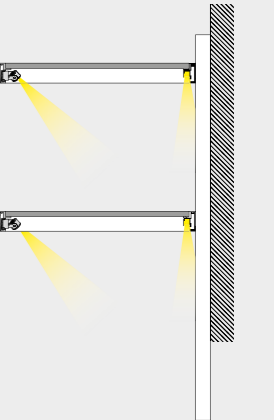
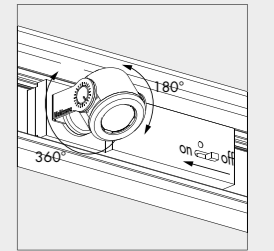
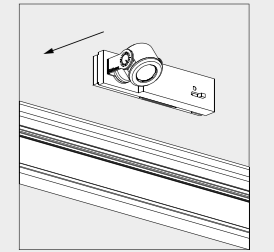
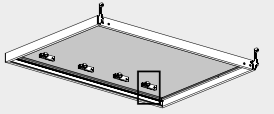

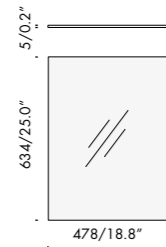

componenti. components.

f9.528.80 ripiano vetro
glass shelf extra chiaro
extra-clear 634mm
25" 3,7kg
8.1lb

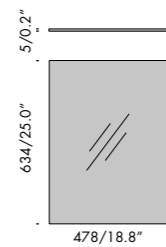

Vb9.528.80.n ripiano vetro
glass shelf nero
black 634mm
25" 4,5kg
9.9lb



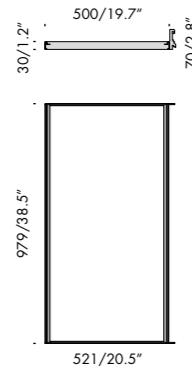
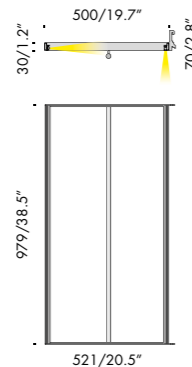
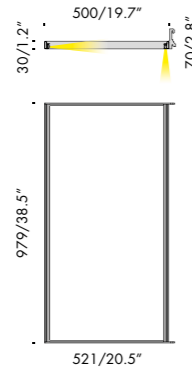
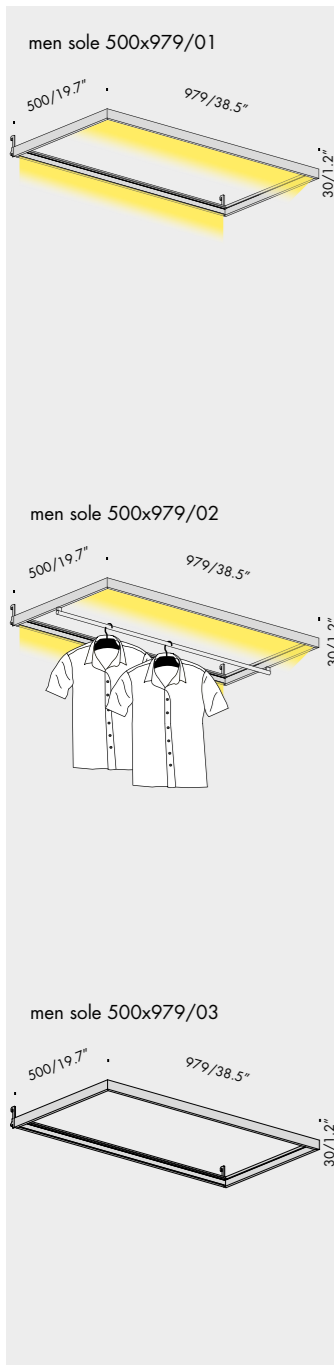

men sole 500x979/01 24Vdc

- Vb7.528.52.2** cornice alluminio lucido senza ripiano 3000K 26W 979mm 2,1kg
polished aluminium frame without shelf 38.5" 4.6lb
- Vb7.528.53.2** cornice nero senza ripiano 3000K 26W 979mm 2,1kg
black frame without shelf 38.5" 4.6lb
- Vb7.528.141** cornice ottone ap-s senza ripiano 3000K 26W 979mm 2,1kg
ottone ap-s frame without shelf 38.5" 4.6lb

Ra	R9	ies tm/30		sdc	Vf	lm/m	W/m	lm/W
95	90	Rf 93	Rg 102	step 2	24	1250	13	96
V0001		5,9 Ta25 °C		vita media · average life		50000 h	L80	B10

men sole 500x979/02 24Vdc

- f7.528.54.2** appendiabiti alluminio lucido 3000K 26W 979mm 2,4kg
senza ripiano polished aluminium clothes hanger
without shelf 38.5" 5.3lb
- f7.528.55.2** appendiabiti nero senza ripiano 3000K 26W 979mm 2,4kg
black clothes hanger without shelf 38.5" 5.3lb
- Vb7.528.142** appendiabiti ottone ap-s senza ripiano 3000K 26W 979mm 2,4kg
ottone ap-s clothes hanger without shelf 38.5" 5.3lb

Ra	R9	ies tm/30		sdc	Vf	lm/m	W/m	lm/W
95	90	Rf 93	Rg 102	step 2	24	1250	13	96
V0001		5,9 Ta25 °C		vita media · average life		50000 h	L80	B10

men sole 500x979/03

- f7.528.56.2** cornice cieca alluminio lucido senza ripiano 979mm 2,1kg
polished aluminium blind frame without shelf 38.5" 4.6lb
- f7.528.57.2** cornice cieca nero senza ripiano 979mm 2,1kg
black blind frame without shelf 38.5" 4.6lb
- Vb7.528.143** cornice cieca ottone ap-s senza ripiano 979mm 2,1kg
ottone ap-s blind frame without shelf 38.5" 4.6lb

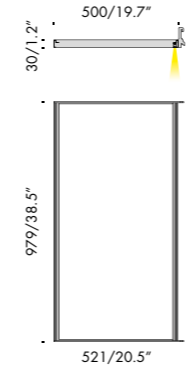

men sole 500x979/04 24Vdc

- Vb7.528.96** cornice alluminio lucido senza ripiano 3000K 13W 979mm 2,1kg
con binario elettrificato per micromen polished aluminium frame without shelf
electrified track for micromen 38.5" 4.6lb
- Vb7.528.97** cornice nero senza ripiano 3000K 13W 979mm 2,1kg
con binario elettrificato per micromen black frame without shelf electrified
track for micromen 38.5" 4.6lb
- Vb7.528.98** cornice ottone ap-s senza ripiano 3000K 13W 979mm 2,1kg
con binario elettrificato per micromen ottone ap-s frame without shelf
electrified track for micromen 38.5" 4.6lb

Ra	R9	ies tm/30		sdc	Vf	lm/m	W/m	lm/W
95	90	Rf 93	Rg 102	step 2	24	1250	13	96
V0001		5,9 Ta25 °C		vita media · average life		50000 h	L80	B10

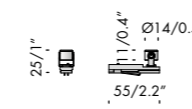



micromen 24Vdc

- Vb9.528.55.1** alluminio lucido adattatore nero55 3000K 13° 0,02kg
polished aluminium nero55 adapter 0.04lb
- Vb9.528.56** alluminio lucido adattatore nero55 3000K 25° 0,02kg
polished aluminium nero55 adapter 0.04lb
- Vb9.528.57** nero55 adattatore nero55 3000K 12° 0,02kg
nero55 adapter 0.04lb
- Vb9.528.58** nero55 adattatore nero55 3000K 23° 0,02kg
nero55 adapter 0.04lb

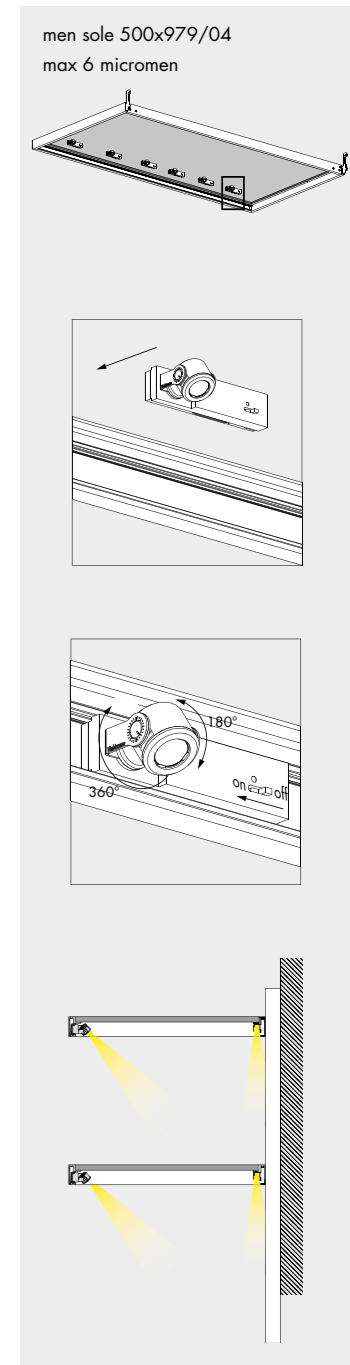
Ra	ies tm-30		sdc	mA	V _{f(min)}	lm	W	lm/W
90	Rf 90	Rg 100	step 2	300	2,8	90	1	90
ca011		les2 • Ta25 °C		vita media · average life		50000 h	L80	B10





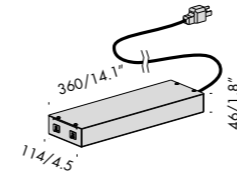

componenti. components.  

f9.528.83.1 ripiano vetro
glass shelf extra chiaro
extra-clear 957mm
37.7" 4,8kg
10.6lb



componenti. components. 120V/24Vdc  dry  

t4.610.u alimentatore j/box con cavo e spina
j-box power supply with cord and plug 100W 0,2kg
0.4lb

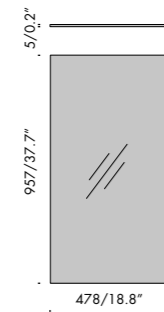

Vb9.528.83.n ripiano vetro
glass shelf nero
black 957mm
37.7" 5,9kg
13lb

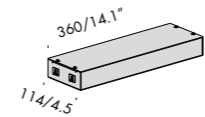

t4.611.u alimentatore j/box
j-box power supply 100W 0,2kg
0.4lb

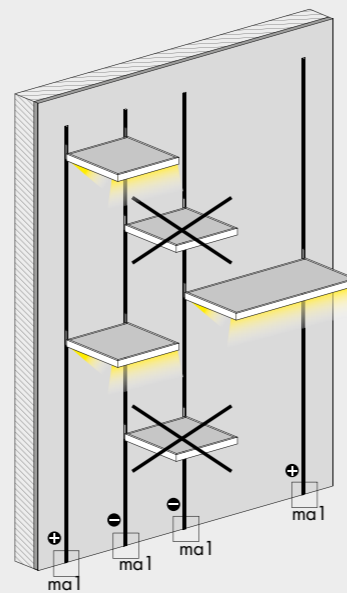
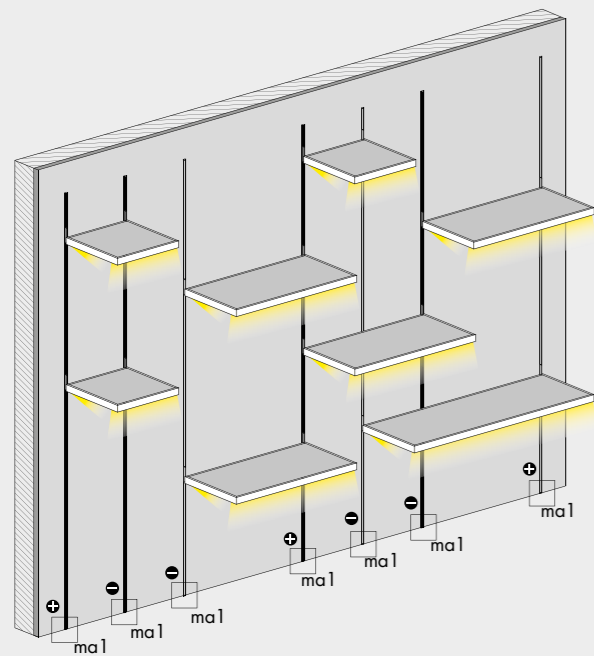
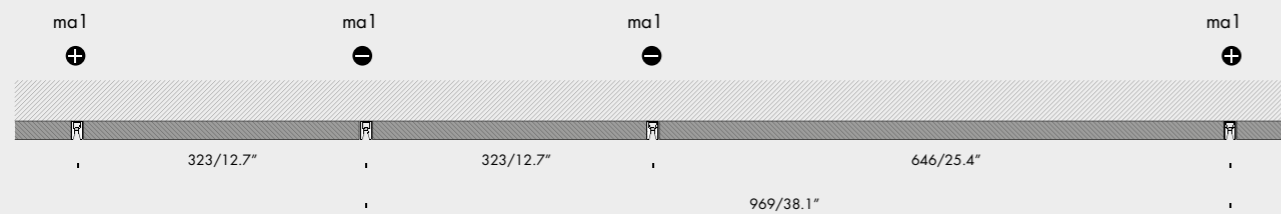

collegamento elettrico · electrical connection
montantelettrico ma1

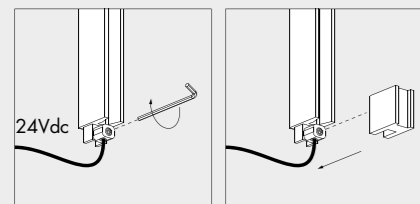

attenzione: l'accensione delle men sole avviene solo se innestate su un montantelettrico + e un montantelettrico -

please note: men sole switches on only when they are fitted on a + montantelettrico and a - montantelettrico



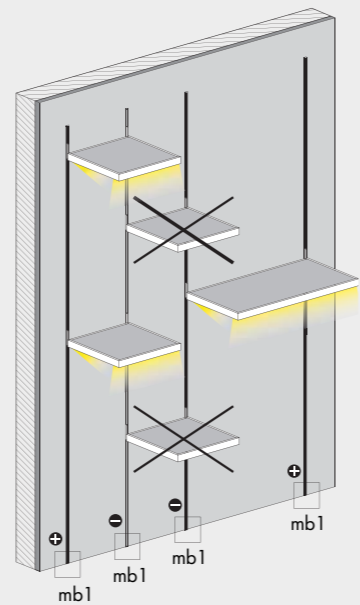
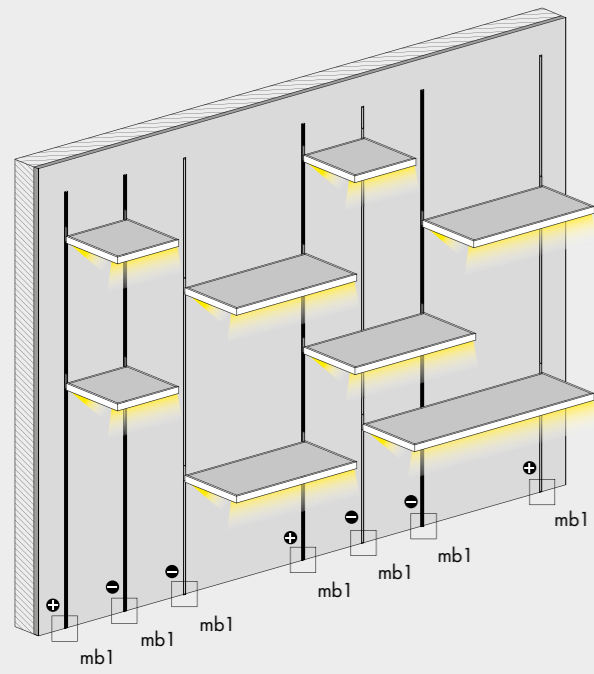
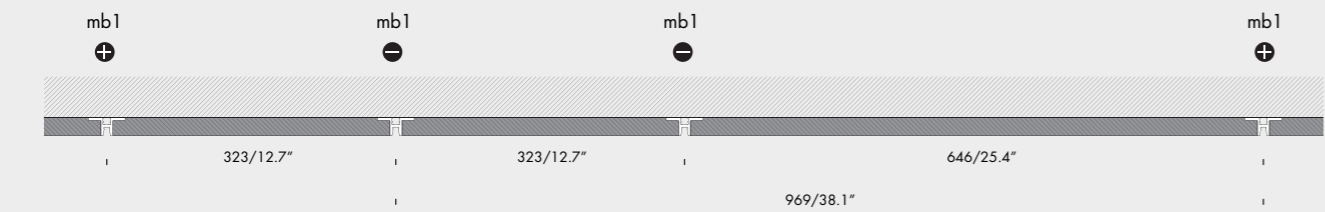

collegamento elettrico - electrical connection
montantelettrico mb1

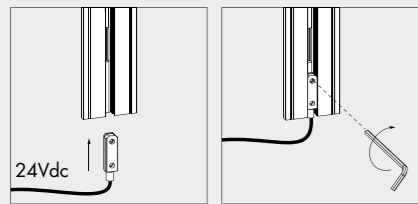

attenzione: l'accensione delle men sole avviene solo se innestate su un montantelettrico + e un montantelettrico -

please note: men sole switches on only when they are fitted on a + montantelettrico and a - montantelettrico



*campana brembana
mora nanni 2007*

la campana brembana è un'ampia cupola asimmetrica che si inserisce nel soffitto. fa leggere la sua rotolante apparentemente, fine avvolta dalla luce che amette senza far vedere la fonte.

non esiste l'apparecchio, vive solo la luce nel forma architettonica, si costruisce un soffito e il più un getto di calcestruzzo, ma una costellazione di occhi in su per scoprire in ogni caso una luce diversa, composta dalla combinazione calibrata di più lampade fluorescenti e led in sistema di controllo in rgb.

si apre un cielo di blu, giallo, bianchi, rossi e luce sfumature, perché la luce genera colore.

la campana brembana è un corpo illuminante prima di tutto è un volume scavo, uno spazio architettonico capace di vivere anche in assenza di luce artificiale perché viene incavato dall'ambiente come il gesso.

è questa l'emozione che ha voluto comunicare, questo progetto, un'emozione fatta di colori, sentire, nuovi, passi e parole, un'emozione e oltre tutto questo, l'emozione di noi.

la campana brembana è a wide asymmetric integrating in the ceiling and showing its apparent curved shape enveloped in the light as from the non-visible source.

the fixture does not exist, just light in the architectural form exists.

the ceiling ceiling is no longer a concrete or but a constellation: raise your eyes up to discover a different light in any "campana", a balance combination of different fluorescent lamps and led, with control system.

a sky of blue, yellow, white, red and all the shades opens above you, because light generates color.

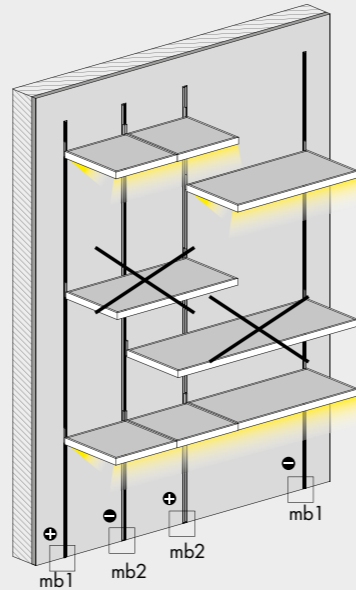
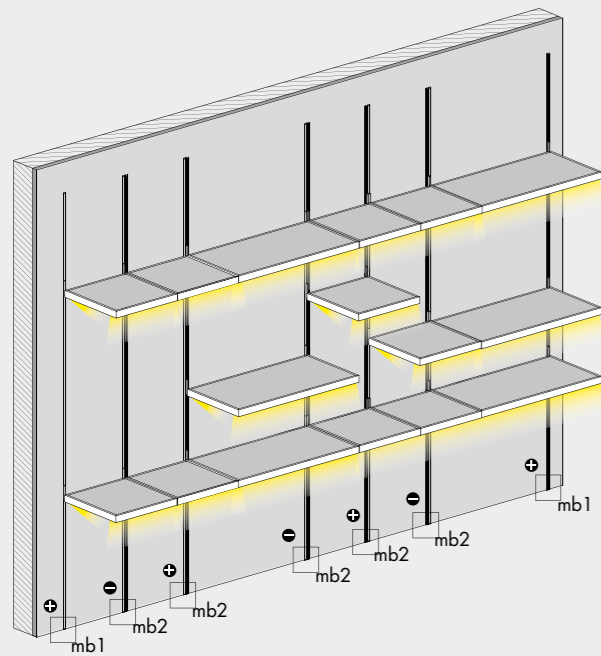
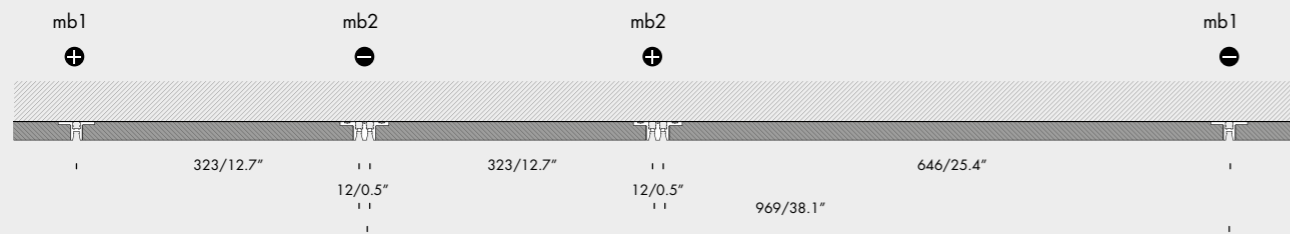

collegamento elettrico · electrical connection
montantelettrico mb1

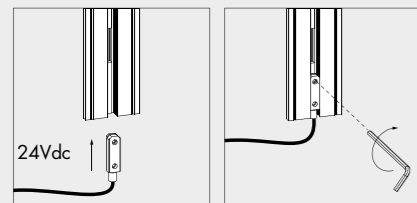

collegamento elettrico · electrical connection
montantelettrico mb2

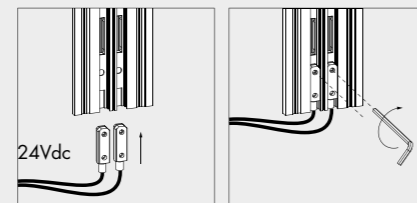

attenzione: l'accensione delle men sole avviene solo se innestate su un montantelettrico + e un montantelettrico -

please note: men sole switches on only when they are fitted on a + montantelettrico and a - montantelettrico



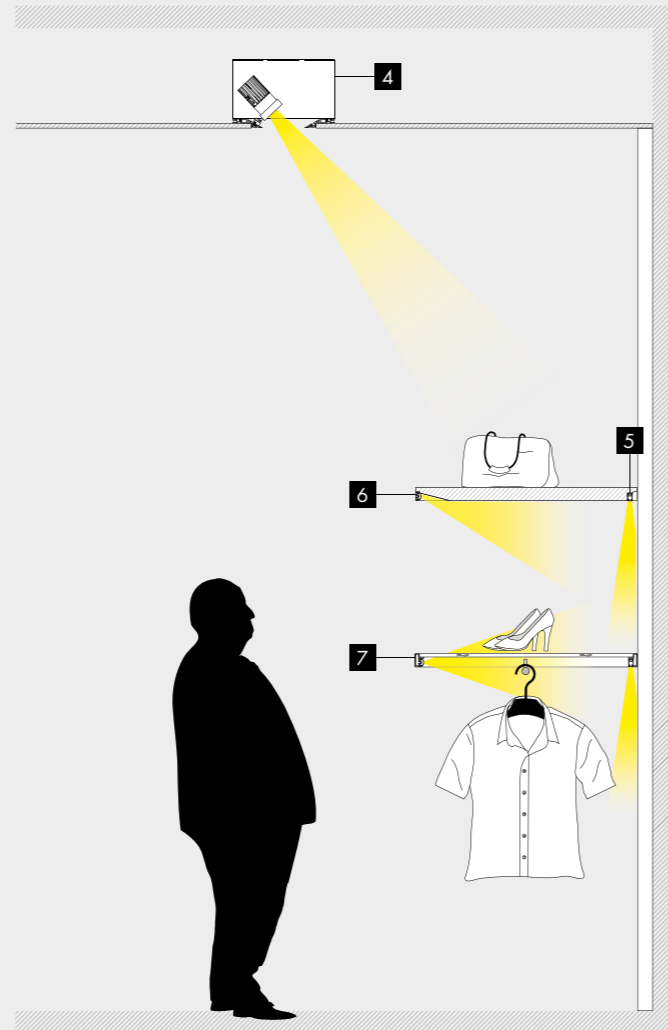
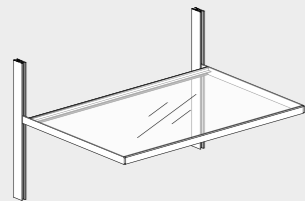
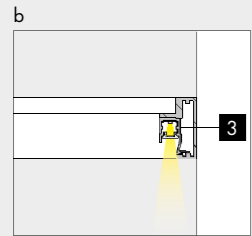
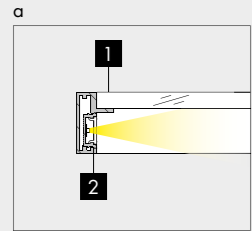
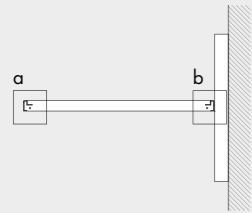

1 vetro spessore · glass thickness 6mm/

2 profilo luce lineare frontale
front linear light profile

3 profilo luce lineare posteriore
rear linear light profile

4 094 system con eco system
094 system with eco system

5 13x8

6 arco led

7 men sole

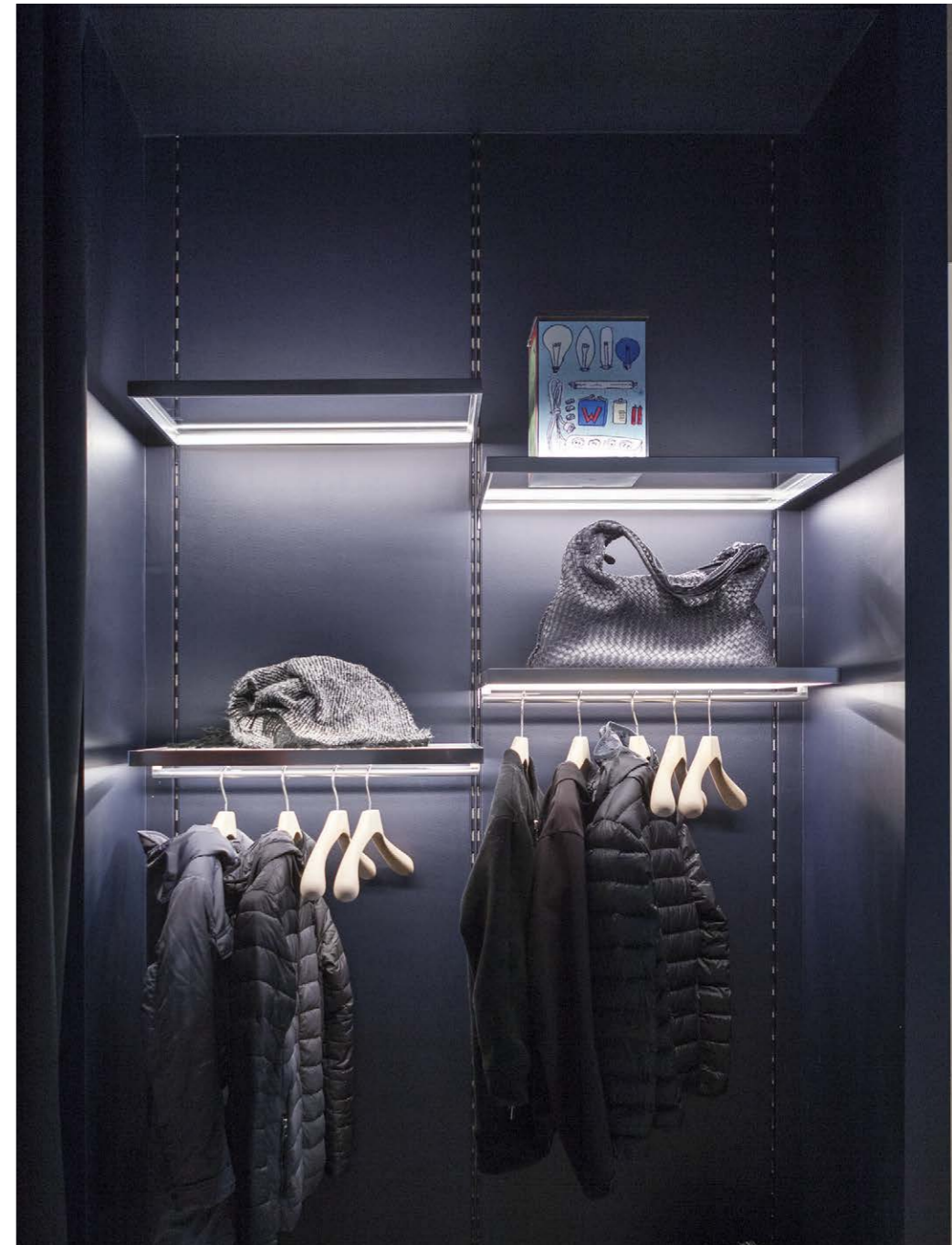

potenza max utilizzabile per ogni onfigurazione personalizzata · max power available for personalized configuration 150W
 portata max · max cap 40kg/m · 88lb/3.2ft

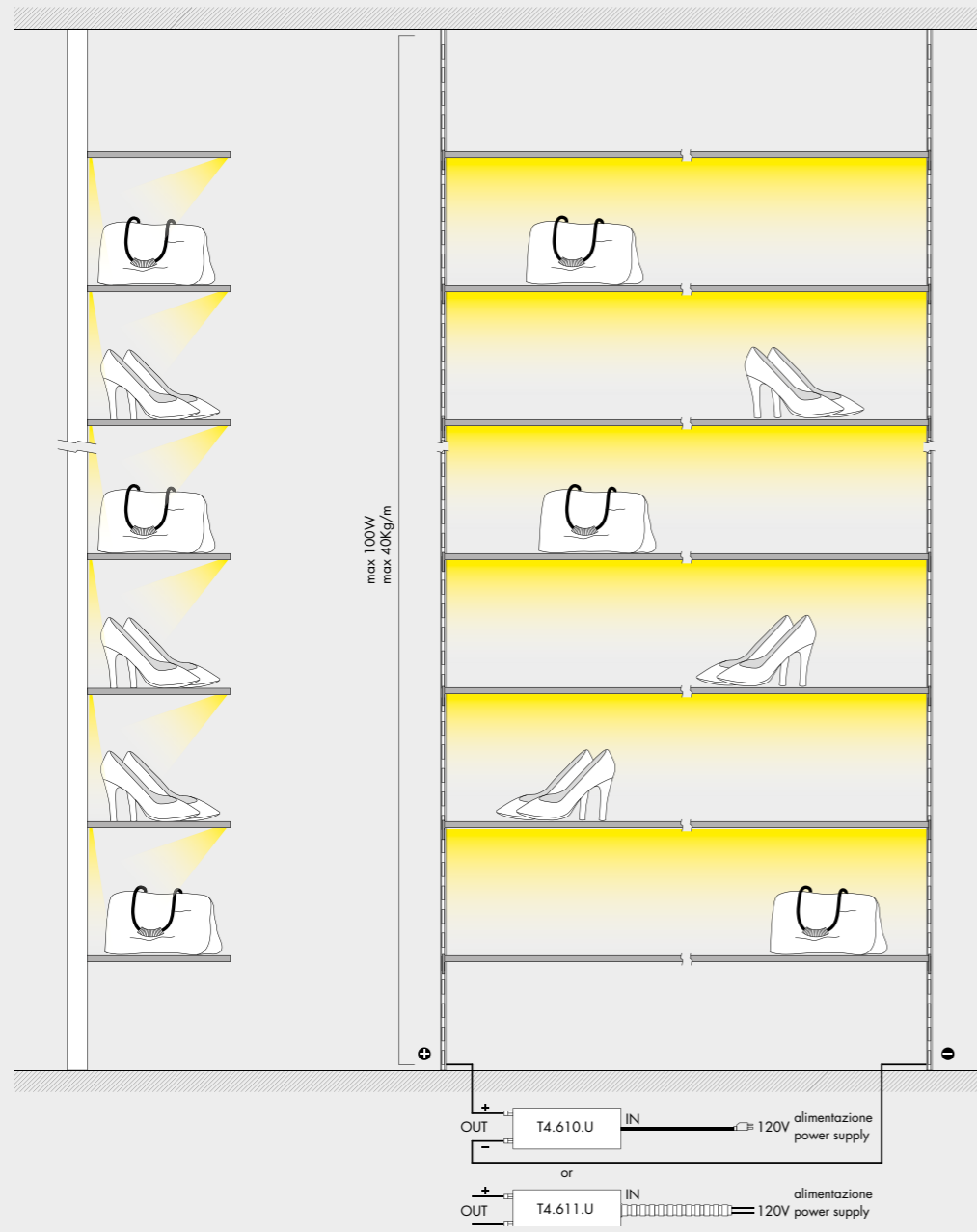

lettura delle tabelle tecniche how to read technical tables

xxxxxxxxxxxxxxxx							120V 50-60Hz	A	wet	UL	UL	UL	i
a	b	c	d	e	f	f	g						

xxxxxxxxxxxxxxxx							120V 50-60Hz	A	wet	UL	UL	UL	i
Vbx.xxx.xx	nero55	3000K	35W	20°	0,8kg	1.8lb							
h	i	l	m	n	g								

componenti. components.

accessori. accessories.

1	2	3	4	5	6	7	8	9	
Ra	R9	ies tm-30		sdc	mA	V _{f (min)}	lm	W	lm/W
98	98	Rf 96	Rg 103	step 1	350	27,6	1240	9,7	128
					500	27,9	1580	14,0	113
xm000	les19	Ta25 °C		vita media · average life		50000 h	L80	B10	
10	11						12	13	

classificazione ambiente di installazione installation location rating

bandella tecnica. posizioni standard simbologie.
data plate. standard arrangement of symbols.

a	nome apparecchio di illuminazione · light fitting name
b	tensione di alimentazione · supply rating (Volt)
c	frequenza di alimentazione · supply frequency (Hertz)
d	alimentatore incluso o escluso · power supply included or not included
e	classificazione ambiente di installazione · installation location rating
f	marchio di certificazione · safety and quality standards certification
g	peso netto · net weight (kg/lb)
h	codice · code
i	finiture · colours and finishes
l	temperatura colore sorgente elettronica colour temperature led source (Kelvin)
m	potenza della sorgente · source power (Watt)
n	gradi fascio luminoso · light beam degrees

componenti. identifica tutti gli elementi indispensabili per la corretta funzionalità e installazione dell'apparecchio di illuminazione.
components. includes all items that are essential to the correct operation and installation of the light fitting.

accessori. si riferisce alle ulteriori parti installabili sull'apparecchio.
accessories. refers to items that can be added to the light fitting.

1	indice di resa cromatica · colour rendering index
2	indice di resa del rosso · red colour rendering index
3	Rf indice di fedeltà colore · colour fidelity index Rg indice di saturazione colore · color gamut index
4	step di macadam · macadam step
5	corrente di alimentazione · power supply current
6	tensione di alimentazione · power supply voltage
7	flusso luminoso · light flux
8	potenza della sorgente · source power
9	efficienza della sorgente · source efficiency
10	codice sorgente elettronica Viabizzuno · Viabizzuno led source code
11	superficie emittente · light emitting surface (mm)
12	% flusso residuo a fine vita · end life % flux
13	% consentita sotto limite · allowed % under limit

wet prodotto classificato per uso esterno · product classified for outdoor use

damp prodotto classificato per uso interno in ambienti umidi (bagno, sauna, ecc..) · product classified for indoor use in damp environments (bathrooms, saunas, etc.)

dry prodotto classificato per uso interno in ambienti asciutti · product classified for indoor use in dry environments

legenda simboli symbols legenda

 prodotto in conformità con le direttive nord americane sui soffioni doccia · produced in compliance with showerheads northamerican directives

 componente certificato per il mercato nord americano idoneo ad essere utilizzato e valutato come parte di in un sistema più complesso
component approved for north american market and suitable to be used and approved as part of a more complex system

 prodotto finito idoneo per essere commercializzato nel mercato nord americano · listed product suitable for the north american market

 prodotto finito idoneo per essere commercializzato nel mercato nord americano · listed product suitable for the north american market

type ic apparecchio di illuminazione ad incasso progettato per funzionare a contatto con materiale isolante.
recessed luminaire designed to work in contact with thermal insulation.

type non-ic apparecchio di illuminazione ad incasso progettato per funzionare in intercapedini che abbiano una certa distanza da materiali isolanti.
recessed luminaire designed to work in cavities that have a minimum dimensions and spacings to thermal insulation.

title24 prodotto conforme allo standard title24 · product compliant with title24 standard

 vetro opalino · opal glass

 vetro sabbiato · sanded glass

 vetro nero fumè · black smoke glass

 vetro trasparente · transparent glass

 vetro bianco latte · white milk glass

 cristallo · crystal

 policarbonato opalino · opal polycarbonate diffuser

 carrabile · drive over

A alimentatore incluso · power supply included

A alimentatore escluso · power supply not included

AR alimentatore remoto incluso · remote power supply included

Ai alimentatore elettronico con controllo intelligente incluso · electronic power supply with smart control included

AiR alimentatore elettronico con controllo intelligente incluso, da installare remoto · electronic power supply with smart control included, to be installed remotely

AS alimentatore a spina incluso · plug power supply included

T trasformatore incluso · transformer included

K kit di cablaggio incluso · wiring kit not included

K kit di cablaggio escluso · wiring kit not included

L lampadina con sorgente elettronica led, ad incandescenza, alogena o fluorescente inclusa.
bulb with led electronic source, incandescent, halogen or fluorescent included.

L lampadina con sorgente elettronica led, ad incandescenza, alogena o fluorescente esclusa.
bulb with led electronic source, incandescent, halogen or fluorescent not included.

PR propulsore dinamico n55 incluso · included

 attenzione: sorgente luminosa led. non guardare mai direttamente a occhio nudo · attention: led light source. never look straight without eye protection

i peso netto · net weight (kg)

 possibilità di combinazione tra interfaccia n55, propulsore dinamico n55 e lampadina n55 · possible combination between n55 interface, propulsore dinamico n55 and n55 bulb

I.d. luce diretta · direct light

I.i. luce indiretta · indirect light

V  disponibile su · available on *Viabizzuno applight* www.Viabizzuno.com *Viabizzuno online*