

MOONBLOOM pendant - sospensione

3000K **SE256 1B INT**
2700K **SE256 5B INT**

Matteo Ugolini design

2021

A - LAMP *corpo lampada* matt black aluminum - *alluminio nero opaco*

E - CEILING CUP *rosone* white plaster - *gesso bianco*

C - ELECTRICAL CABLE *cavo elettrico* black 2 meters - *2 metri nero*

OPTIONAL *accessorio* power supply equipped - *alimentatore incluso*

ELECTRICAL SYSTEM *disp. elettrico* LED 24V, 16,8W*, 1821 lm CRI≥90

PACKAGING *imballo* 50x50x40 cm





NET WEIGHT *peso netto* 4,8 KG

GROSS WEIGHT *peso lordo* 7,9 KG

IP RATE *grado protezione* IP20

CERTIFICATION *conformità* IEC 60598-1:2014 EN 60598-1:2015

EMISSION *emissione* unidirectional - *unidirezionale*

-  direct - *diretta*
-  filtered - *filtrata*
-  indirect - *indiretta*
-  none - *assente*

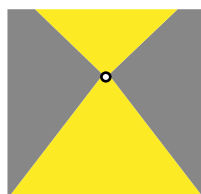

*(phase cut dimmable - dimmerabile taglio di fase)



COLLECTION *collezione*

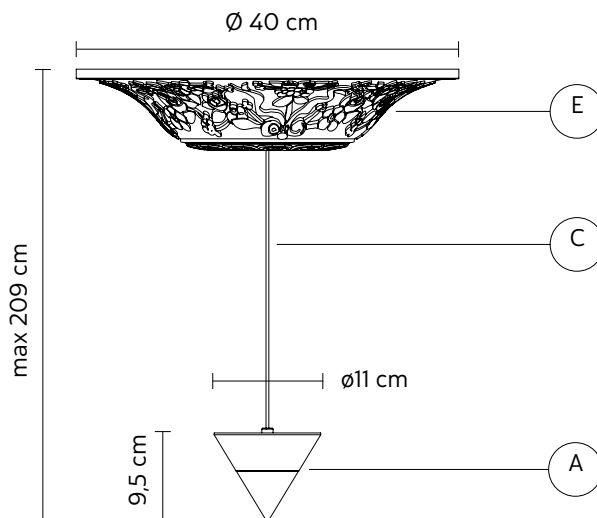
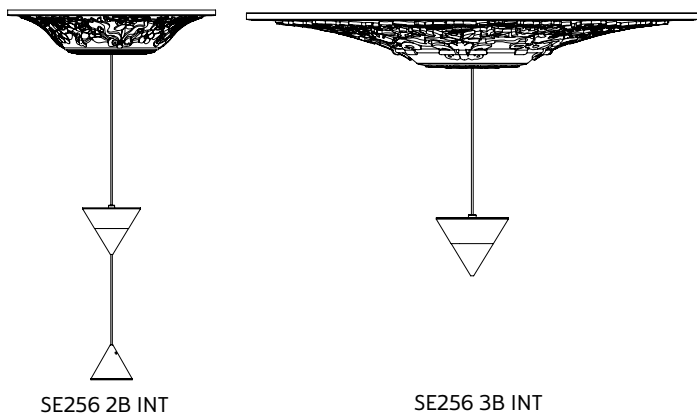

MOONBLOOM pendant - sospensione

3000K **SE256 4B INT**
2700K **SE256 8B INT**

Matteo Ugolini design

2021

A - LAMP *corpo lampada* matt black aluminum - *alluminio nero opaco*

E - CEILING CUP *rosone* white plaster - *gesso bianco*

C - ELECTRICAL CABLE *cavo elettrico* black 3 meters - *3 metri nero*

OPTIONAL *accessorio* power supply equipped - *alimentatore incluso*

ELECTRICAL SYSTEM top: LED 24V*, 16,8W, 1821 lm CRI≥90
bottom: LED 24V*, 8,4W, 907 lm CRI≥90

PACKAGING *imballo* 104x91x17 cm

NET WEIGHT *peso netto* 15,2 KG

GROSS WEIGHT *peso lordo* 19,2 KG

IP RATE *grado protezione* IP20

CERTIFICATION *conformità* IEC 60598-1:2014 EN 60598-1:2015

EMISSION *emissione* bidirectional - *bidirezionale*

 direct - *diretta*

 filtered - *filtrata*

 indirect - *indiretta*

 none - *assente*

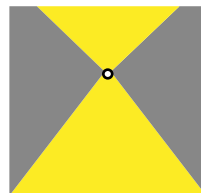

*(phase cut dimmable - dimmerabile taglio di fase)



COLLECTION *collezione*

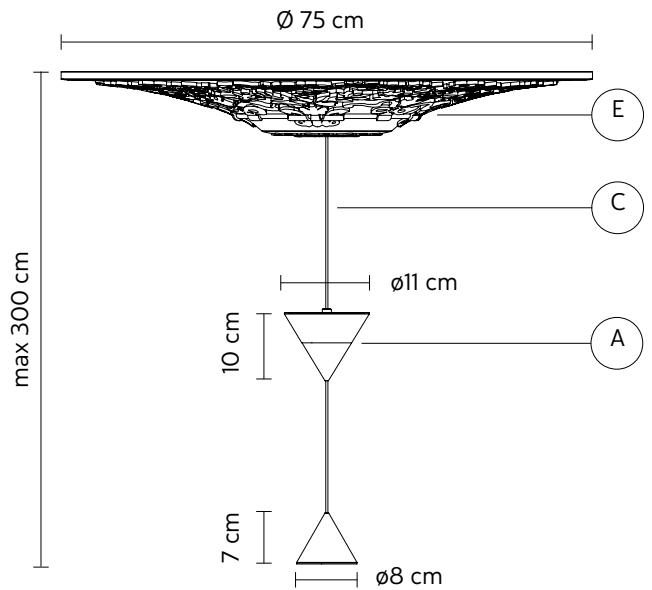
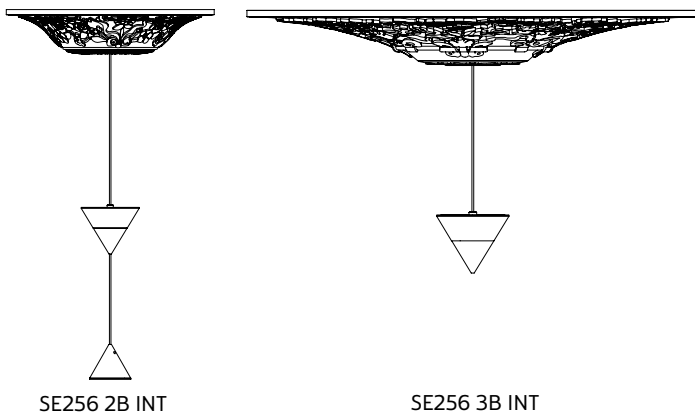

MOONBLOOM pendant - sospensione

3000K **SE256 2B INT**
2700K **SE256 6B INT**

Matteo Ugolini design

2021

A - LAMP *corpo lampada* matt black aluminum - *alluminio nero opaco*

E - CEILING CUP *rosone* white plaster - *gesso bianco*

C - ELECTRICAL CABLE *cavo elettrico* black 3 meters - *3 metri nero*

OPTIONAL *accessorio* power supply equipped - *alimentatore incluso*

ELECTRICAL SYSTEM

top: LED 24V*, 16,8W, 1821 lm CRI≥90
bottom: LED 24V*, 8,4W, 907 lm CRI≥90

PACKAGING *imballo* 50x50x40 cm

NET WEIGHT *peso netto* 5,2 KG

GROSS WEIGHT *peso lordo* 8,4 KG

IP RATE *grado protezione* IP20

CERTIFICATION *conformità* IEC 60598-1:2014 EN 60598-1:2015

EMISSION *emissione* bidirectional - *bidirezionale*

 direct - *diretta*

 filtered - *filtrata*

 indirect - *indiretta*

 none - *assente*



*(phase cut dimmable - dimmerabile taglio di fase)



COLLECTION *collezione*

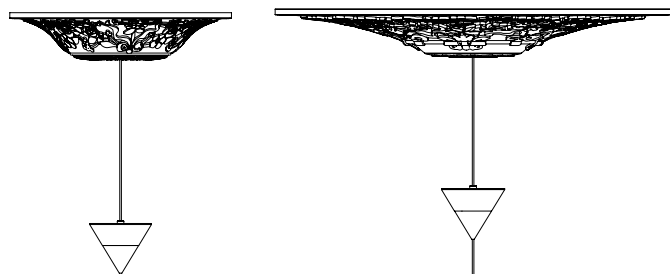

SE256 1B INT

SE256 4B INT

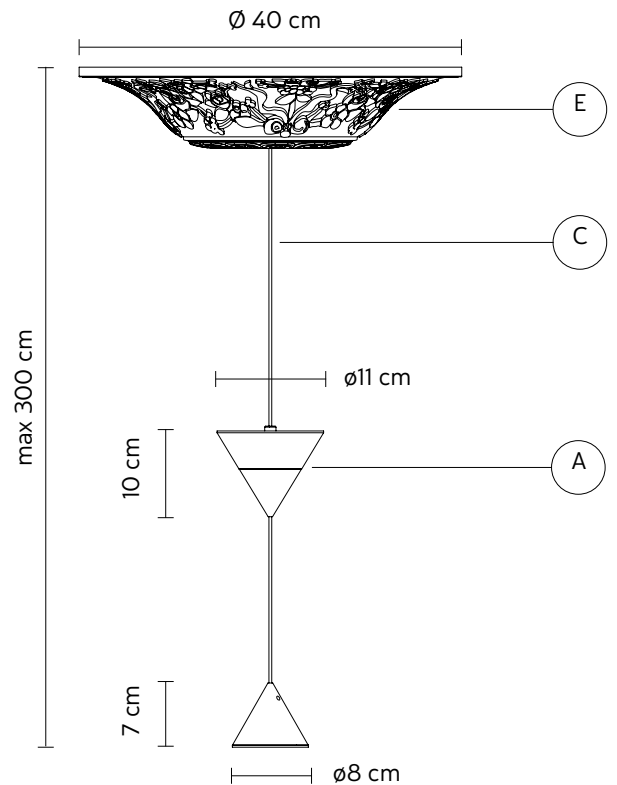

MOONBLOOM pendant - sospensione

3000K **SE256 3B INT**
2700K **SE256 7B INT**

Matteo Ugolini design

2021

A - LAMP *corpo lampada* matt black aluminum - *alluminio nero opaco*

E - CEILING CUP *rosone* white plaster - *gesso bianco*

C - ELECTRICAL CABLE *cavo elettrico* black 2 meters - *2 metri nero*

OPTIONAL *accessorio* power supply equipped - *alimentatore incluso*

ELECTRICAL SYSTEM *disp. elettrico* LED 24V, 16,8W*, 1821 lm CRI≥90

PACKAGING *imballo* 104x91x17 cm





NET WEIGHT *peso netto* 14,5 KG

GROSS WEIGHT *peso lordo* 18,8 KG

IP RATE *grado protezione* IP20

CERTIFICATION *conformità* IEC 60598-1:2014 EN 60598-1:2015

EMISSION *emissione* unidirectional - *unidirezionale*

-  direct - *diretta*
-  filtered - *filtrata*
-  indirect - *indiretta*
-  none - *assente*

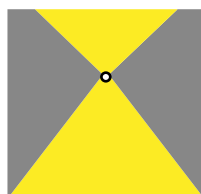

*(phase cut dimmable - dimmerabile taglio di fase)



COLLECTION *collezione*

